

# CATÁLOGO DE PEÇAS

PARTS CATALOG

CATÁLOGO DE PIEZAS

CATALOGUE DE PIÈCES



# ÍNDICE







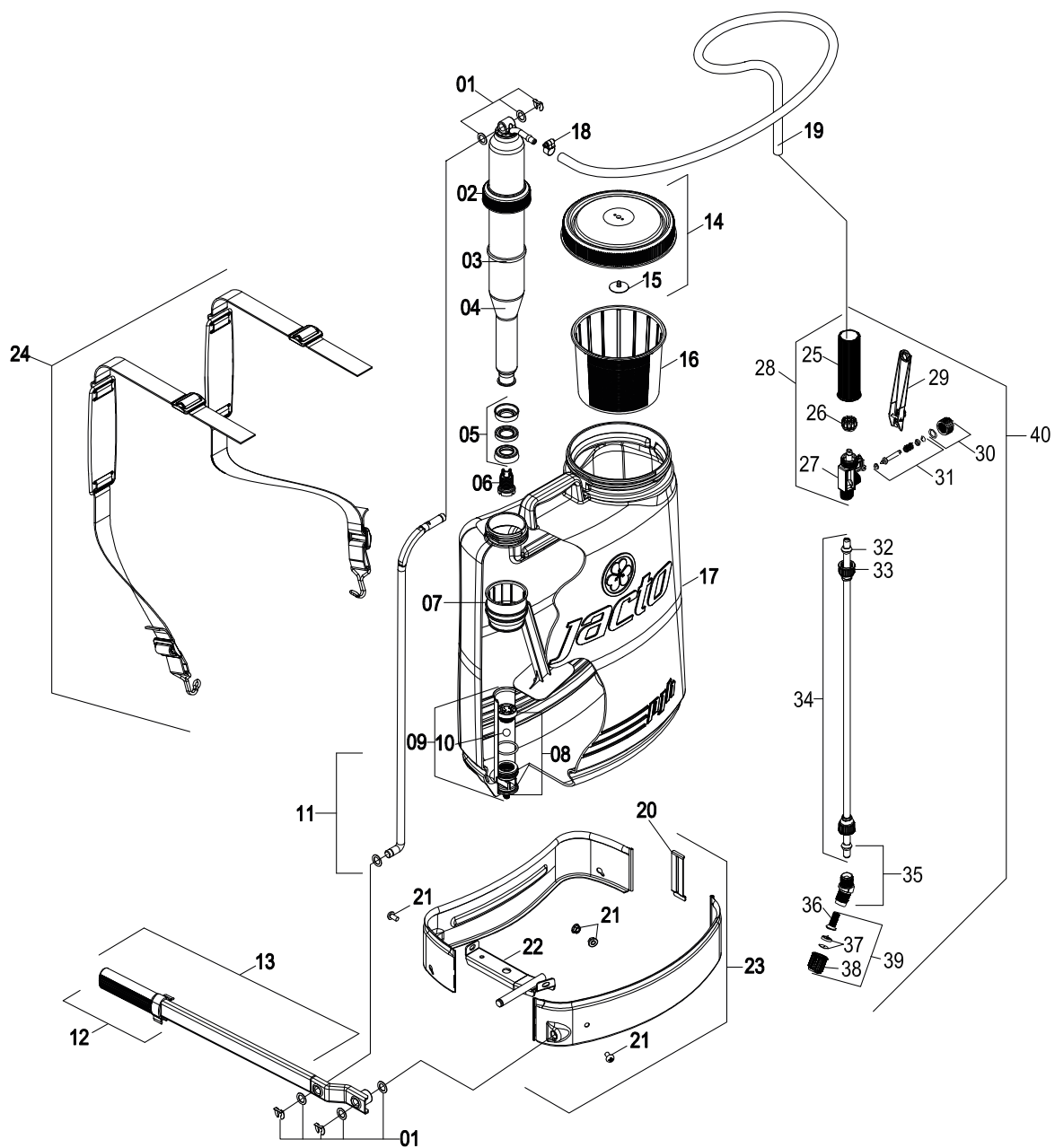









SUMMARY/ TABLA DE CONTENIDO/ TABLE DES MATIÈRES

















JACTO PJH .....	3
JACTO PJ .....	7
JACTO HD .....	12
JACTO XP .....	16
JACTO HH-5 .....	20
JACTO PJB .....	23
JACTO DJB .....	28
JACTO PJM .....	33
JACTO PR-40 .....	37
ACESSÓRIOS/ ACCESSORIES/ ACCESORIOS/ ACCESSOIRES .....	41
REGISTROS/ TRIGGER VALVE/ ROBINET .....	44

# JACTO PJH



# JACTO PJH

Nº	CÓDIGO CODE	DESCRIÇÃO DESCRIPTION DESCRIPCIÓN	IMAGEM IMAGE IMAGEN	QT. QTY. CT.	UTILIZAÇÃO UTILIZATION UTILIZACIÓN UTILISER	NCM HS CODE	EAN BARCODE
1	1198800	JOGO DE ARRUELAS E ANÉIS TRAVAS WASHERS AND LOCKED RINGS SET JUEGO DE ARANDELA Y ANILLO TRABA JEU DE RONDELLES ET BOULONS		10	PJ, PJH, XP, HD	7318.22.00	17896660843022
2	831222	PORTA GAXETA PJH GASKET HOLDER PJH PORTA PRENSAESTOPA PJH PORTE-JOINT PJH		10	PJ, PJH	3926.90.90	27896821547247
3	831230	GAXETA 7X50,6 PJH GASKET 7x50,6 PRENSAESTOPA 7x50,6 JOINT 7x50,6		20	PJ, PJH	3926.90.90	27896821551145
4	635284	CÂMARA COMPLETA CHAMBER ASSEMBLY CAMARA COMPLETA CHAMBRE COMPLÈTE		1	PJ, PJH	8424.90.90	7896821540732
5	336479	JOGO DE ÊMBOLOS (SANTOPRENE) E ESPAÇADOR PISTON CUP AND SPACER JUEGO DE EMBOLO PLASTICO PISTON ET ESPACEUR		10	PJ, PJH	3926.90.90	7909436928441
6	1192736	VÁLVULA DA CÂMARA COM ESFERA PISTON CUP FASTENER FIJADOR DEL EMBOLO VALVE DE LA CHAMBRE		10	PJ, PJH	8481.80.99	27896660841506
7	300582	MEXEDOR PJH PJH AGITATOR MEZCLADOR PJH AGITATEUR PJH		5	PJ, PJH	8424.90.90	17896821549121
8	661124	FIXADOR COMPLETO PJH FASTENER ASSEMBLY PJH FIJADOR COMPLETO PJH FIXATEUR COMPLÈTE PJH		2	PJH	8424.90.90	17896821551926
9	925917	CILINDRO COMPLETO PJH CYLINDER ASSEMBLY PJH CYLINDRE COMPLÈTE PJH		20	PJH	8424.90.90	7909436917810
10	715474	ESFERA 11,11 MM BALL 11,11 MM SPHÈRE 11,11MM		20	PJH	3926.90.90	7896660847986
11	1197400	HASTE LARANJA COM TRAVAS ROD WITH LOCK HASTE CON TRABA TIGE D'OPÉRATION		1	PJ, PJH, XP, HD	8424.90.90	7896660836980
12	495812	MANOPLA DA ALAVANCA COM TRAVA HANDGRIP WITH LOCK MANIJA CON TRABA MANETTE COMPLÈTE		1	PJ, PJH, XP, HD	8424.90.90	7896821573990
13	615005	ALAVANCA DE ACIONAMENTO PUMPING LEVER PALANCA CON MANIJA LEVIER AVEC GANTELET		1	PJ, PJH, XP, HD	8424.90.90	7896821509753
14	1253304	TAMPA C/ DIAFRAGMA PJH LID AND DIAPHRAGM TAPA CON DIAFRAGMA COUVERCLE AVEC DIAPHRAGME		1	PJH	3923.50.00	7909436917339
15	1168542	DIAFRAGMA DA TAMPA (NITRÍLICA) LID DIAPHRAGM (NITRILE) DIAFRAGMA DE LA TAPA (NITRILE) DIAPHRAGM DE LA COUVERCLE (NITRILE)		50	PJH, PJ, XP, HD, PJB-C, PJB, DJB	4016.99.90	7909436909006
16	647131	COADOR PJH STRAINER COLADOR TAMIS		5	PJH	8424.90.90	17896821547035
17	942086	DEPÓSITO TANK DEPOSITO RÉSERVOIR		1	PJH	8424.90.90	7896821505762

Nº	CÓDIGO CODE	DESCRIÇÃO DESCRIPTION DESCRIPCIÓN	IMAGEM IMAGE IMAGEN	QT. QTY. CT.	UTILIZAÇÃO UTILIZATION UTILIZACIÓN UTILISER	NCM HS CODE	EAN BARCODE
18	1187239	ABRAÇADEIRA SIMPLEX D 12-14 INOX CLAMP Ø12-14 STAINLESS STEEL ABRAZADERA ACERO INOXIDABLE Ø12-14 AGRAFE ACIER INOXYDABLE Ø12-14		10	PJ, PJH	7326.19.00	17896660837724
19	1230970	MANG. FLEX PVC PT 250 5/16" 250 5/16" BLACK FLEX PVC HOSE MANGUERA FLEXIBLE PVC PRETA 250 5/16" TUYAU 250 5/16"		5	PJ, PJH	3917.39.00	7909436916912
20	825471	GRAMPO DA BASE BASE CLAMP GRAPA DE LA BASE CRAMPON DE LA BASE		5	PJ, PJH	7317.00.20	17896821556037
21	229476	JOGO DE PARAFUSO E PORCA SCREWS, WASHERS AND NUTS SET JUEGO DE TORNILLOS, ARANDELAS Y TUERCAS BOULONS ET ÉCROUS		5	PJH	7318.15.00	17896821523770
22	942714	REFORÇO PJH REINFORCEMENT REFUERZO RENFORT		5	PJH	8424.90.90	27896821547889
23	229484	EMBASAMENTO COMPLETO BASE ASSEMBLY BASE COMPLETA BASE COMPLÈTE		1	PJH	8424.90.90	7896821551851
24	1234554	CINTA COMPLETA (PJH) STRAP ASSEMBLY CINTA COMPLETA COURROIE COMPLÈTE		10	PJH	8424.90.90	7896660884998
25	1220962	CABO DO REGISTRO LP 601 TRIGGER VALVE HANDLE LP 601 CABO DEL REGISTRO LP 601 POIGNÉE DU ROBINET LP 601		5	PJH, PJ, XP, HD, PJB-C, PJB, DJB	8424.90.90	7909436924115
26	1220966	PINÇA LP 601 CLIP LP 601 PINZA LP 601 FERMETURE LP 601		20	PJH, PJ, XP, HD, PJB-C, PJB, DJB	3926.90.90	7909436924474
27	1220968	CORPO DO REGISTRO LP 601 TRIGGER VALVE BODY LP 601 CUERPO DEL REGISTRO LP 601 CORPS DU REGISTRE LP 601		5	PJH, PJ, XP, HD, PJB-C, PJB, DJB	8481.90.90	7909436924603
28	1217605	REGISTRO COMPLETO LP 601 TRIGGER VALVE LP 601 REGISTRO COMPLETO LP 601 ROBINET COMPLÈTE LP 601		20	PJH, PJ, XP, HD, PJB-C, PJB, DJB	8481.80.99	7896660870397
29	1220951	ALAVANCA DO REGISTRO LP 601 TRIGGER VALVE LEVER LP 601 PALANCA DEL REGISTRO LP 601 LEVIER DU ROBINET LP 601		20	PJH, PJ, XP, HD, PJB-C, PJB, DJB	8424.90.90	7909436923989
30	996058	TAMPA DO REGISTRO LP 601/605 COM VEDAÇÃO TRIGGER VALVE CAP LP 601/ 605 AND SEAL TAPA DEL REGISTRO LP 601/605 CON VEDACIÓN COUVERCLE DU ROBINET LP 601/605 AVEC JOINT		20	PJH, PJ, XP, HD, PJB-C, PJB, DJB	8481.90.90	7909436923972
31	1230971	AGULHA DO REGISTRO TRIGGER VALVE NEEDLE AGUJA DEL REGISTRO AIGUILLE DU ROBINET		20	PJH, PJ, XP, HD, PJB-C, PJB, DJB	8424.90.90	7896660860046
32	1220972	JUNTA CÔNICA CONE PACKING JUNTA CÓNICA CONE PACKING		20	PJ, PJH, XP, HD, PJBC, PJB	3926.90.90	7909436925037
33	1220969	PORCA CÔNICA 11/16 SCREW CAP 11/16 TUERCA CONICA 11/16 ECROU CONIQUE 11/16		10	PJH, PJ, XP, HD, PJB-C, PJB, DJB	3926.90.90	7909436924924
34	100131	TUBO DE PULVERIZAÇÃO STAINLESS STEEL LANCE TUBO DE PULVERIZACIÓN TUBE DE PULVÉRISATION		1	PJH, PJ, XP, HD, PJB-C, PJB, DJB	8424.90.90	7896821501252

# JACTO PJH

Nº	CÓDIGO CODE	DESCRIÇÃO DESCRIPTION DESCRIPCIÓN	IMAGEM IMAGE IMAGEN	QT. QTY. CT.	UTILIZAÇÃO UTILIZATION UTILIZACIÓN UTILISER	NCM HS CODE	EAN BARCODE
35	635276	<b>JUNÇÃO E JUNTA CÔNICA</b> JOINT AND CONE PACKING UNIÓN CON JUNTA CÔNICA JOINT AND CONE PACKING		10	PJH, PJ, XP, HD, PJB-C, PJB, DJB	3917.40.90	7909436931311
36	1168545	<b>FILTRO DO BICO M50/60</b> NOZZLE FILTER M50/60 FILTRO DE LA BOQUILLA M50/60 FILTRE DE LA BUSE M50/60		20	PJH, PJ, XP, HD, PJB-C, PJB, DJB	8424.90.90	7896660860053
37	1168547	<b>BICO JD 12</b> JD 12 NOZZLE BOQUILLA JD 12 BUSE JD 12		50	PJH, PJ, XP, HD, PJB-C, PJB, DJB	8424.90.90	7909436924856
38	1168546	<b>CAPA DO BICO</b> NOZZLE CAP CAPA DE LA BOQUILLA COUVERCLE DE LA BUSE		30	PJH, PJ, XP, HD, PJB-C, PJB, DJB	8424.90.90	7909436925310
39	427062	<b>CONJUNTO DE BICOS JD-12</b> NOZZLE JD 12 ASSEMBLY BOQUILLA COMPLETA NOZZLE JD 12 ASSEMBLY		20	PJH, PJ, XP, HD, PJB-C, PJB, DJB	8424.90.90	7909436928052
40	915769	<b>LANÇA COMPLETA</b> LANCE AND TRIGGER VALVE LANZA COMPLETA LANCE COMPLÈTE		10	PJH, PJ, XP, HD, PJB-C, PJB, DJB	8424.90.90	7909436917605

## PEÇAS OPCIONAIS JACTO PJH/

OPTIONAL PARTS JACTO PJH/ PIEZAS OPCIONALES JACTO PJH/ PIECES EN OPTION JACTO PJH





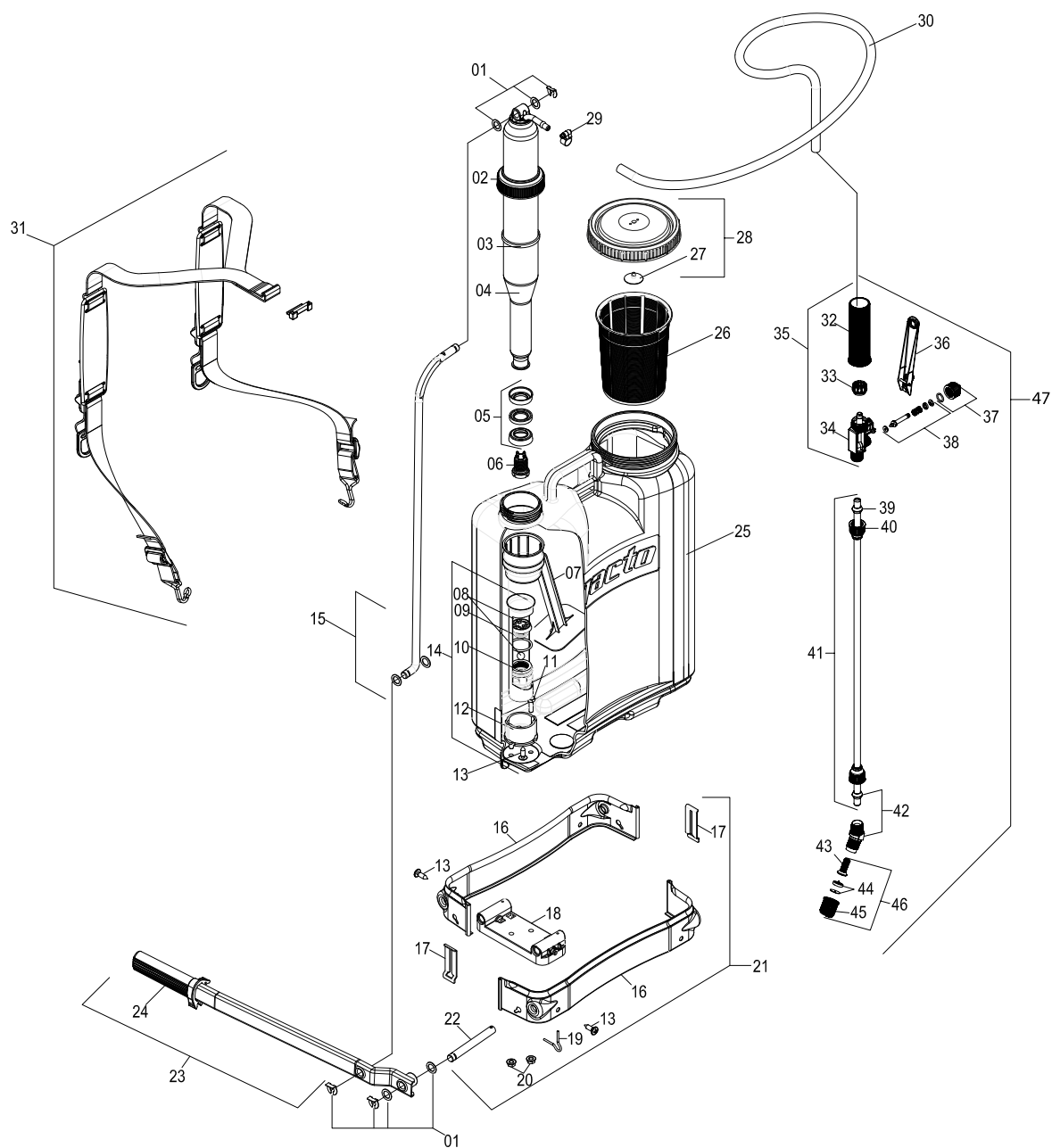











Nº	CÓDIGO CODE	DESCRIÇÃO DESCRIPTION DESCRIPCIÓN	IMAGEM IMAGE IMAGEN	QT. QTY. CT.	UTILIZAÇÃO UTILIZATION UTILIZACIÓN UTILISER	NCM HS CODE	EAN BARCODE
1	1253305	<b>COADOR PJH</b> STRAINER COLADOR TAMIS		1	PJH	8424.90.90	7909436917346
2	1221543	<b>VÁLVULA DA CÂMARA COM ESFERA (LATÃO)</b> CHAMBER VALVE AND SPHERE (BRASS) VALVULA DE LA CAMARA CON ESFERA (LATÓN) VALVE DE LA CHAMBRE (LAIION)		10	PJ, PJH	8481.80.99	17896821552503
3	647032	<b>ÊMBOLO DE COURO E ESPAÇADOR</b> LEATHER PISTON CUP AND SPACER JUEGO DE EMBOLO DE CUERO PISTON DE CUIR ET ESPACEUR		10	PJ, PJH	4205.00.00	7909436928984
4	880534	<b>ÊMBOLO DE VITON E ESPAÇADOR</b> VITON PISTON CUP AND SPACER JUEGO DE EMBOLO DE VITON PISTON DE VITON ET ESPACEUR		1	PJ, PJH	4016.93.00	7896660887401
5	831016	<b>KIT REPARO PJH</b> REPAIR KIT PJH KIT DE REPARACION PJH TROUSSE DE RÉPARATION PJH		10	PJ, PJH	8481.90.90	7909436923965
6	744383	<b>CINTA ALMOFADA</b> PADDED STRAP BELT CONJUNTO DE CORREA ACOLCHADA COURROIE DE PADDLE		1	PJH	8424.90.90	7896821573556
7	1234559	<b>CINTA COMPLETA COM REGULAGEM</b> STRAP ASSEMBLY WITH ADJUSTMENT CINTA COMPLETA CON REGULACIÓN COURROIE COMPLÈTE AVEC RÉGULATION		10	PJH	8424.90.90	7896660882185
8	612051	<b>EMBASAMENTO 8000</b> BASE PJH MODEL 8000 BASE COMPLETA PJH MODELO 8000 BASE COMPLÈTE PJH 8000		1	PJH 8000	8424.90.90	7896821593288
9	942102	<b>JOGO DE ARRUELAS E CONTRAPINOS</b> WASHERS AND COTTER PIN SET JUEGO DE ARANDELAS Y CONTRACLAVIJAS RONDELLES ET SET DE BROCHE COTTER		10	PJH 8000	8481.80.99	17896821523695
10	1221195	<b>CÂMARA COM VÁLVULA DE LATÃO</b> BRASS VALVE CHAMBER ASSEMBLY CAMARA COMPLETA CON VALVULA DE LATÓN CHAMBRE COMPLÈTE AVEC VALVE EN LAITON		1	PJ, PJH	8424.90.90	7896660889078
11	1214566	<b>CÂMARA COM ÊMBOLO DE VITON</b> CHAMBER ASSEMBLY W/ VITON PISTON CUP CAMARA COMPLETA CON EMBOLO DE VITON CHAMBRE ASSEMBLY AVEC PISTON DE VITON		1	PJ, PJH	8424.90.90	7896660887104















# JACTO PJ



Nº	CÓDIGO CODE	DESCRIÇÃO DESCRIPTION DESCRIPCIÓN	IMAGEM IMAGE IMAGEN	QT. QTY. CT.	UTILIZAÇÃO UTILIZATION UTILIZACIÓN UTILISER	NCM HS CODE	EAN BARCODE
1	1198800	JOGO DE ARRUELAS E ANÉIS TRAVAS WASHERS AND LOCKED RINGS SET JUEGO DE ARANDELA Y ANILLO TRABA JEU DE RONDELLES ET BOULONS		10	PJ, PJH, XP, HD	7318.22.00	17896660843022
2	831222	PORTA GAXETA PJH GASKET HOLDER PJH PORTA PRENSAESTOPA PJH PORTE-JOINT PJH		10	PJ, PJH	3926.90.90	27896821547247
3	831230	GAXETA 7X50,6 PJH GASKET 7x50,6 PRENSAESTOPA 7x50,6 JOINT 7x50,6		20	PJ, PJH	3926.90.90	27896821551145
4	635284	CÂMARA COMPLETA CHAMBER ASSEMBLY CAMARA COMPLETA CHAMBRE COMPLÈTE		1	PJ, PJH	8424.90.90	7896821540732
5	336479	JOGO DE ÊMBOLOS (SANTOPRENE) E ESPAÇADOR PISTON CUP AND SPACER JUEGO DE EMBOLO PLASTICO PISTON ET ESPACEUR		10	PJ, PJH	3926.90.90	7909436928441
6	1192736	VÁLVULA DA CÂMARA COM ESFERA PISTON CUP FASTENER FIJADOR DEL EMBOLO VALVE DE LA CHAMBRE		10	PJ, PJH	8481.80.99	7896660843025
7	300582	MEXEDOR PJH PJH AGITATOR MEZCLADOR PJH AGITATEUR PJH		5	PJ, PJH	8424.90.90	7896660843025
8	715474	ESFERA 11,11 MM BALL 11,11 MM SPHÈRE 11,11MM		20	PJH	3926.90.90	7896660843025
9	11668	ORING ORI-122		1	PJH, PJ	4016.93.00	7896821522585
10	433359	SEDE DA VALVULA DO CILINDRO VALVE SEAT BASE DE LA ESFERA DEL CILINDRO SIÈGE DE LA SOUPAPE		1	PJ	8481.90.90	7896821589045
11	351486	PARAFUSO M 6X1,0X 20C70 SCREW M 6X1,0X 20C70 TORNILLO M 6X1,0X 20C70 BOULON M 6X1,0X 20C70		1	PJ	7318.15.00	7899144882060
12	433367	BASE DO CILINDRO CYLINDER BASE BASE DEL CILINDRO BASE DE CYLINDRE		1	PJ	8424.90.90	7896821588826
13	211227	PARAFUSO PH.6,3X19 SCREW PH.6,3X19 TORNILLO PH.6,3X19 BOULON PH.6,3X19		1	PJ	7318.15.00	7896821529881
14	1253724	CILINDRO COMPLETO PJ CYLINDER ASSEMBLY PJ CYLINDRE COMPLÈTE PJ		5	PJ	8424.90.90	7909436917773
15	1197400	HASTE LARANJA COM TRAVAS ROD WITH LOCK HASTE CON TRABA TIGE D'OPÉRATION		1	PJ, PJH, XP, HD	8424.90.90	7896660836980
16	942888	BASE SIMETRICA BASE		1	PJ	8424.90.90	7896821524008
17	942896	GRAMPO DA BASE BASE CLAMP GRAPA DE LA BASE CRAMPON DE LA BASE		1	PJ	7317.00.20	7896821588291





Nº	CÓDIGO CODE	DESCRIÇÃO DESCRIPTION DESCRIPCIÓN	IMAGEM IMAGE IMAGEN	QT. QTY. CT.	UTILIZAÇÃO UTILIZATION UTILIZACIÓN UTILISER	NCM HS CODE	EAN BARCODE
18	1253303	REFORÇO DA BASE BASE REINFORCEMENT REFUERZO DE LA BASE RENFORT		1	PJ	8424.90.90	7909436917322
19	433888	TRAVA DO EIXO SHAFT LOCK TRABA DEL EJE ANNEAU DE VERROUILLAGE		1	PJ	7320.90.00	7896821561638
20	743914	JOGO DE PORCAS COM FLANGE NUTS SET JUEGO DE TUERCAS ÉCROUS		2	PJ	7318.16.00	7896821555279
21	635821	EMBASAMENTO COMPLETO BASE ASSEMBLY BASE COMPLETA BASE COMPLÈTE		1	PJ	8424.90.90	7896821530580
22	433896	EIXO DA ALAVANCA COM TRAVA AXLE WITH LOCK EJE CON TRABA ESSIEU AVEC BASE E GOUPPILES		1	PJ	8424.90.90	7896821550168
23	615005	ALAVANCA DE ACIONAMENTO PUMPING LEVER PALANCA CON MANIJA LEVIER AVEC GANTELET		1	PJ, PJH, XP, HD	8424.90.90	7896821509753
24	495812	MANOPLA DA ALAVANCA COM TRAVA HANDGRIP WITH LOCK MANIJA CON TRABA MANETTE COMPLÈTE		1	PJ, PJH, XP, HD	8424.90.90	7896821573990
25	964643	DEPÓSITO PJ-16 TANK PJ-16 DEPOSITO PJ-16 RÉSEVOIR PJ-16		1	PJ-16	8424.90.90	7896660805252
25A	1235081	DEPÓSITO PJ-18 TANK PJ-18 DEPOSITO PJ-18 RÉSEVOIR PJ-18		1	PJ-18	8424.90.90	7896660834924
25B	1235122	DEPÓSITO PLUS TANK PLUS DEPOSITO PLUS RÉSEVOIR PLUS		1	PLUS	8424.90.90	7896660834948
26	1220919	COADOR STRAINER COLADOR TAMIS		1	PJ, HD, PJB-C, PJB, DJB	8424.90.90	7896821548929
27	1168542	DIAFRAGMA DA TAMPA (NITRÍLICA) LID DIAPHRAGM (NITRILE) DIAFRAGMA DE LA TAPA (NITRILE) DIAPHRAGM DE LA COUVERCLE (NITRILE)		50	PJH, PJ, XP, HD, PJB-C, PJB, DJB	4016.99.90	7909436909006
28	1220918	TAMPA C/ DIAFRAGMA LID AND DIAPHRAGM TAPA CON DIAFRAGMA COUVERCLE AVEC DIAPHRAGME		1	PJ, HD, PJB-C, PJB, DJB	8424.90.90	7896660888286
29	1187239	ABRAÇADEIRA SIMPLEX D 12-14 INOX CLAMP Ø12-14 STAINLESS STEEL ABRAZADERA ACERO INOXIDABLE Ø12-14 AGRAFE ACIER INOXYDABLE Ø12-14		10	PJH, PJ	7326.19.00	17896660837724
30	1230970	MANG. FLEX PVC PT 250 5/16" 250 5/16" BLACK FLEX PVC HOSE MANGUERA FLEXIBLE PVC PRETA 250 5/16" TUYAU 250 5/16"		10	PJ, PJH	7326.19.00	7909436916912
31	1234565	CINTA COMPLETA COM REGULAGEM STRAP ASSEMBLY WITH ADJUSTMENT CINTA COMPLETA CON REGULACIÓN COURROIE COMPLÈTE AVEC RÉGULATION		1	PJ	8424.90.90	7896660833576
32	1220962	CABO DO REGISTRO LP 601 TRIGGER VALVE HANDLE LP 601 CABO DEL REGISTRO LP 601 POIGNÉE DU ROBINET LP 601		5	PJH, PJ, XP, HD, PJB-C, PJB, DJB	8424.90.90	7909436924115

Nº	CÓDIGO CODE	DESCRIÇÃO DESCRIPTION DESCRIPCIÓN	IMAGEM IMAGE IMAGEN	QT. QTY. CT.	UTILIZAÇÃO UTILIZATION UTILIZACIÓN UTILISER	NCM HS CODE	EAN BARCODE
33	1220966	<b>PINÇA LP 601</b> CLIP LP 601 PINZA LP 601 FERMETURE LP 601		20	PJH, PJ, XP, HD, PJB-C, PJB, DJB	3926.90.90	7909436924474
34	1220968	<b>CORPO DO REGISTRO LP 601</b> TRIGGER VALVE BODY LP 601 CUERPO DEL REGISTRO LP 601 CORPS DU REGISTRE LP 601		5	PJH, PJ, XP, HD, PJB-C, PJB, DJB	8481.90.90	7909436924603
35	1217605	<b>REGISTRO COMPLETO LP 601</b> TRIGGER VALVE LP 601 REGISTRO COMPLETO LP 601 ROBINET COMPLÈTE LP 601		20	PJH, PJ, XP, HD, PJB-C, PJB, DJB	8481.80.99	7896660870397
36	1220951	<b>ALAVANCA DO REGISTRO LP 601</b> TRIGGER VALVE LEVER LP 601 PALANCA DEL REGISTRO LP 601 LEVIER DU ROBINET LP 601		20	PJH, PJ, XP, HD, PJB-C, PJB, DJB	8424.90.90	7909436923989
37	996058	<b>TAMPA DO REGISTRO LP 601/605 COM VEDAÇÃO</b> TRIGGER VALVE CAP LP 601/ 605 AND SEAL TAPA DEL REGISTRO LP 601/605 CON VEDACIÓN COUVERCLE DU ROBINET LP 601/605 AVEC JOINT		20	PJH, PJ, XP, HD, PJB-C, PJB, DJB	8481.90.90	7909436923972
38	1230971	<b>AGULHA DO REGISTRO</b> TRIGGER VALVE NEEDLE AGUJA DEL REGISTRO AIGUILLE DU ROBINET		20	PJH, PJ, XP, HD, PJB-C, PJB, DJB	8424.90.90	7896660860046
39	1220972	<b>JUNTA CÔNICA</b> CONE PACKING JUNTA CONICA CONE PACKING		20	PJ, PJH, XP, HD, PJBC, PJB	3926.90.90	7909436925037
40	1220969	<b>PORCA CÔNICA 11/16</b> SCREW CAP 11/16 TUERCA CONICA 11/16 ECROU CONIQUE 11/16		10	PJH, PJ, XP, HD, PJB-C, PJB, DJB	3926.90.90	7909436924924
41	100131	<b>TUBO DE PULVERIZAÇÃO</b> STAINLESS STEEL LANCE TUBO DE PULVERIZACIÓN TUBE DE PULVÉRISATION		1	PJH, PJ, XP, HD, PJB-C, PJB, DJB	8424.90.90	7896821501252
42	635276	<b>JUNÇÃO E JUNTA CÔNICA</b> JOINT AND CONE PACKING UNIÓN CON JUNTA CÔNICA JOINT AND CONE PACKING		10	PJH, PJ, XP, HD, PJB-C, PJB, DJB	3917.40.90	7909436931311
43	1168545	<b>FILTRO DO BICO M50/60</b> NOZZLE FILTER M50/60 FILTRO DE LA BOQUILLA M50/60 FILTRE DE LA BUSE M50/60		20	PJH, PJ, XP, HD, PJB-C, PJB, DJB	8424.90.90	7896660860053
44	1168547	<b>BICO JD 12 BICO JD 12</b> JD 12 NOZZLE BOQUILLA JD 12 BUSE JD 12		50	PJH, PJ, XP, HD, PJB-C, PJB, DJB	8424.90.90	7909436924856
45	1168546	<b>CAPA DO BICO</b> NOZZLE CAP CAPA DE LA BOQUILLA COUVERCLE DE LA BUSE		30	PJH, PJ, XP, HD, PJB-C, PJB, DJB	8424.90.90	7909436925310
46	427062	<b>CONJUNTO DE BICOS JD-12</b> NOZZLE JD 12 ASSEMBLY BOQUILLA COMPLETA NOZZLE JD 12 ASSEMBLY		20	PJH, PJ, XP, HD, PJB-C, PJB, DJB	8424.90.90	7909436928052
47	915769	<b>LANÇA COMPLETA</b> LANCE AND TRIGGER VALVE LANZA COMPLETA LANCE COMPLÈTE		10	PJH, PJ, XP, HD, PJB-C, PJB, DJB	8424.90.90	7909436917605









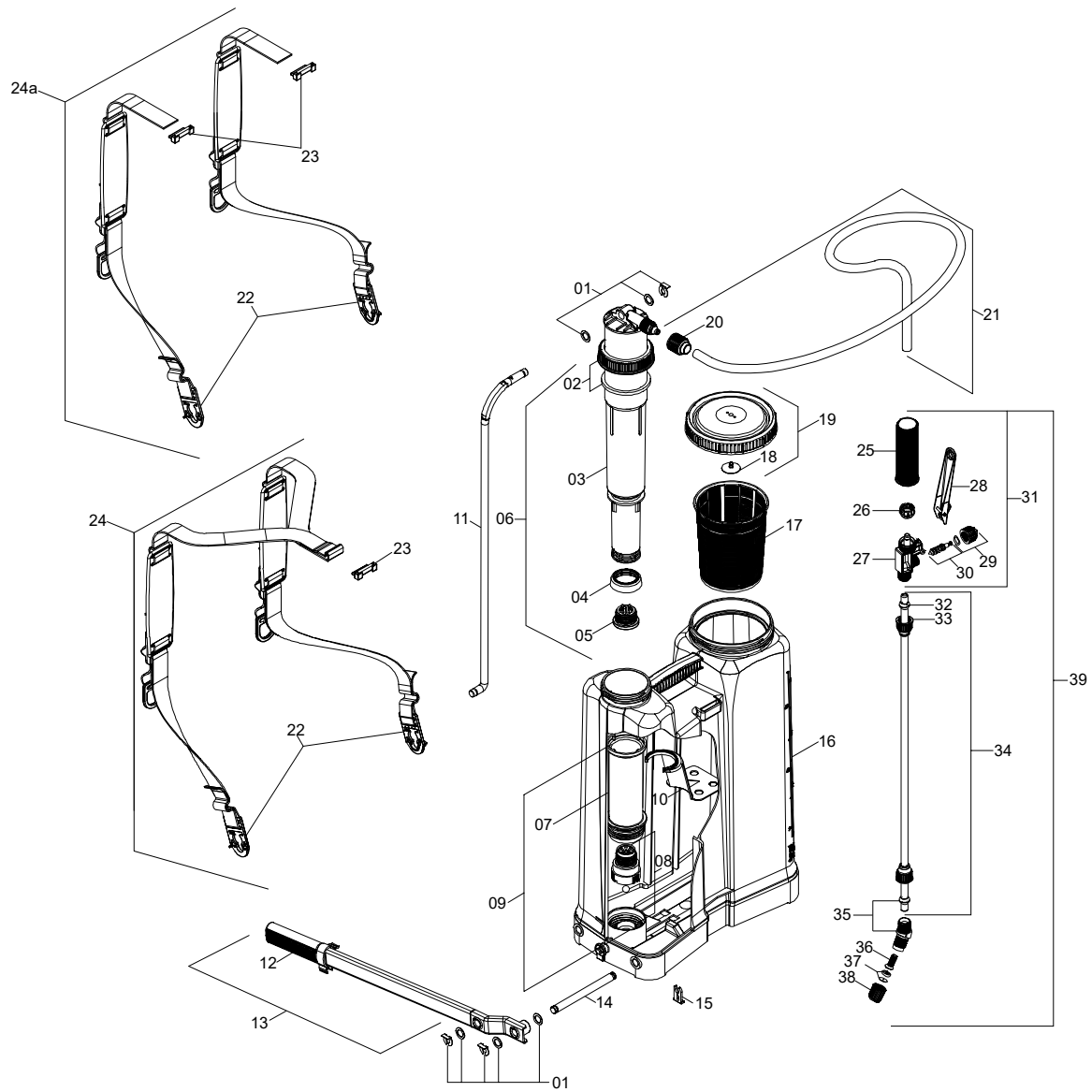







## PEÇAS OPCIONAIS JACTO PJ/

OPTIONAL PARTS JACTO PJ/ PIEZAS OPCIONALES JACTO PJ/ PIECES EN OPTION JACTO PJ

Nº	CÓDIGO CODE	DESCRIÇÃO DESCRIPTION DESCRIPCIÓN	IMAGEM IMAGE IMAGEN	QT. QTY. CT.	UTILIZAÇÃO UTILIZATION UTILIZACIÓN UTILISER	NCM HS CODE	EAN BARCODE
1	878041	DEPÓSITO CD-400 TANK CD-400 DEPOSITO CD-400 RÉSEVOIR CD-400		1	CD-400	8424.90.90	7896660850504
2	402297	VÁLVULA DA CÂMARA COM ESFERA (LATÃO) CHAMBER VALVE AND SPHERE (BRASS) VALVULA DE LA CAMARA CON ESFERA (LATÓN) VALVE DE LA CHAMBRE (LAIION)		10	PJ, PJH	8481.80.99	17896821552503
3	647032	ÊMBOLO DE COURO E ESPAÇADOR LEATHER PISTON CUP AND SPACER JUEGO DE EMBOLO DE CUERO PISTON DE CUIR ET ESPACEUR		10	PJ, PJH	4205.00.00	7909436928984
4	880534	ÊMBOLO DE VITON E ESPAÇADOR VITON PISTON CUP AND SPACER JUEGO DE EMBOLO DE VITON PISTON DE VITON ET ESPACEUR		1	PJ, PJH	4016.93.00	7896660887401
5	831016	KIT REPARO PJH REPAIR KIT PJH KIT DE REPARACION PJH TROUSSE DE RÉPARATION PJH		10	PJ, PJH	8481.90.90	7909436923965
6	573006	CINTA ALMOFADA PADDED STRAP BELT CONJUNTO DE CORREA ACOLCHADA COURROIE DE PADDLE		1	PJ	8424.90.90	7896821558911
7	1234554	CINTA COMPLETA SEM REGULAGEM STRAP ASSEMBLY WITHOUT ADJUSTMENT CINTA COMPLETA SIN REGULACIÓN COURROIE COMPLÈTE		1	PJ	8424.90.90	7896660832197
8	48116	MANGUEIRA COM PESCADOR HOSE WITH DIP TUBE MANGUERA CON TUBO RECOLECTOR TUYAU AVEC PECHEUR		1	CD-400, HD	3917.39.00	7896821551837
9	878199	CÂMARA COMPLETA CD-400 BRASS VALVE CHAMBER ASSEMBLY CD-400 CAMARA COMPLETA CD-400 CHAMBRE COMPLÈTE CD-400		1	CD-400	8413.91.90	7896821586914
10	1221195	CÂMARA COM VÁLVULA DE LATÃO BRASS VALVE CHAMBER ASSEMBLY CAMARA COMPLETA CON VALVULA DE LATÓN CHAMBRE COMPLÈTE AVEC VALVE EN LAITON		1	PJ, PJH	8424.90.90	7896660889078
11	1214566	CÂMARA COM ÊMBOLO DE VITON CHAMBER ASSEMBLY W/ VITON PISTON CUP CAMARA COMPLETA CON EMBOLO DE VITON CHAMBRE ASSEMBLY AVEC PISTON DE VITON		1	PJ, PJH	8424.90.90	7896660887104

# JACTO HD



Nº	CÓDIGO CODE	DESCRIÇÃO DESCRIPTION DESCRIPCIÓN	IMAGEM IMAGE IMAGEN	QT. QTY. CT.	UTILIZAÇÃO UTILIZATION UTILIZACIÓN UTILISER	NCM HS CODE	EAN BARCODE
1	1198800	JOGO DE ARRUELAS E ANÉIS TRAVAS WASHERS AND LOCKED RINGS SET JUEGO DE ARANDELA Y ANILLO TRABA JEU DE RONDELLES ET BOULONS		10	PJ, PJH, XP, HD	7318.22.00	17896660843022
2	907121	PORTA GAXETA E GAXETA HD GASKET HOLDER AND GASKETHD PORTA PRENSAESTOPA Y PRENSAESTOPA HD PORTE-JOINT ET JOINT HD		1	HD	3926.90.90	7899144843856
3	951053	CORPO DA CÂMARA COM ÊBOLO CHAMBER BODY AND PISTON CUP CUERPO DE LA CÁMARA CON EMBOLO CORPS DE LA CHAMBRE AVEC PISTON		1	HD	8424.90.90	7899144874928
4	214585	ÊBOLO Ø45 X 12 (SANTOPRENE) PISTON CUP Ø45 X 12 (SANTOPRENE) EMBOLO Ø45 X 12 (SANTOPRENE) PISTON Ø45 X 12 (SANTOPRENE)		20	HD	4016.93.00	27896821553071
5	1173630	FIXADOR DO ÊBOLO COM ESFERA FASTENER WITH SPHERE FIJADOR DEL EMBOLO CON ESFERA SOUPAPE DU BILLE		1	HD	8424.90.90	7899144894414
6	314724	CÂMARA COMPLETA CHAMBER ASSEMBLY CAMARA COMPLETA CHAMBRE COMPLÈTE		1	HD	8424.90.90	7899144871408
7	635599	CORPO DO CILINDRO HD CYLINDER BODY HD CUERPO DEL CILINDRO CORPS DE CYLINDRE		1	HD	8424.90.90	7896821558348
8	1224903	FIXADOR DO EMBOLO DO CILINDRO CYLINDER PISTON CUP FIXER FIJADOR DEL EMBOLO DEL CILINDRO FIXATEUR DU JOINT		1	HD	8424.90.90	7896660896182
9	277368	CILINDRO COMPLETO SEM VÁLVULA CYLINDER ASSEMBLY WITHOUT VALVE CILINDRO COMPLETO SIN VALVULA CYLINDRE COMPLÈTE SANS VALVE		1	HD	8424.90.90	7896821546468
10	214619	MEXEDOR HD HD GITATOR MEZCLADOR HD AGITATEUR HD		1	HD	8424.90.90	7896821546802
11	1197400	HASTE LARANJA COM TRAVAS ROD WITH LOCK HASTE CON TRABA TIGE D'OPÉRATION		1	PJ, PJH, XP, HD	8424.90.90	7896660836980
12	495812	MANOPLA DA ALAVANCA COM TRAVA HANDGRIP WITH LOCK MANIJA CON TRABA MANETTE COMPLÈTE		1	PJ, PJH, XP, HD	8424.90.90	7896821573990
13	615005	ALAVANCA DE ACIONAMENTO PUMPING LEVER PALANCA CON MANIJA LEVIER AVEC GANTELET		1	PJ, PJH, XP, HD	8424.90.90	7896660843025
14	293324	EIXO DA ALAVANCA LEVER SHAFT EJE DE LA PALANCA ESSIEU DU LEVIER		1	XP, HD	7318.24.00	7896821509753
15	277350	TRAVA DO EIXO HD AXIS LOCK CONTRACLAVIJA TRABA FLÉAU HD		1	XP, HD	8424.90.90	7896821567326
16	267211	DEPÓSITO COMPLETO HD-400 COMPLETE TANK HD-400 RÉSERVOIR COMPLÈTE HD-400		1	HD-400	8424.90.90	
16A	305185	DEPÓSITO COMPLETO HD-550 COMPLETE TANK HD-550 RÉSERVOIR COMPLÈTE HD-550		1	HD-500	8424.90.90	

# JACTO HD

Nº	CÓDIGO CODE	DESCRIÇÃO DESCRIPTION DESCRIPCIÓN	IMAGEM IMAGE IMAGEN	QT. QTY. CT.	UTILIZAÇÃO UTILIZATION UTILIZACIÓN UTILISER	NCM HS CODE	EAN BARCODE
17	1220919	<b>COADOR</b> TANK STRAINER COLADOR TAMIS		1	PJ, HD, PJB-C, PJB, DJB	8424.90.90	7896660888309
18	1168542	<b>DIAFRAGMA DA TAMPA (NITRÍLICA)</b> LID DIAPHRAGM (NITRILE) DIAFRAGMA DE LA TAPA (NITRILE) DIAPHRAGM DE LA COUVERCLE (NITRILE)		50	PJH, PJ, XP, HD, PJB-C, PJB, DJB	4016.99.90	7909436909006
19	1220918	<b>TAMPA COM DIAFRAGMA</b> LID AND DIAPHRAGM TAPA CON DIAFRAGMA COUVERCLE AVEC DIAPHRAGM		1	PJ, HD, PJB-C, PJB, DJB	8424.90.90	7896660888286
20	942193	<b>PORCA S20 X 1,5</b> SCREW CAP S20 X 1,5 TUERCA S20 X 1,5 ÉCROU S20 X 1,5		10	PJH, PJ, XP, HD, PJB-C, PJB, DJB	3926.90.90	7896821551912
21	48116	<b>MANG FLEX PVC PT 5/16" X 1650</b> 5/16" X 1650 BLACK FLEX PVC HOSE MANGUERA FLEXIBLE PVC PRETA 5/16" X 1650 TUYAU 250 5/16" X 1650		1	HD, CD-400	3917.39.00	7896821551837
22	1220973	<b>FIVELA HD</b> HD BUCKLE BOUCLE HD HEBILLA HD		2	HD, PJB	8424.90.90	7909436915274
23	1222671	<b>TRAVA DA CINTA</b> STRAP LOCK TRABA DE LA CINTA LOQUET DE LA COURROIE		5	HD	8424.90.90	7909436914642
24	838185	<b>CINTA COMPLETA HD-400</b> STRAP ASSEMBLY HD-400 BRETELLE COMPLÈTE HD-400		1	HD-400	8424.90.90	7896821567883
24A	996025	<b>CINTA COMPLETA HD-550</b> STRAP ASSEMBLY HD-550 BRETELLE COMPLÈTE HD-550		1	HD-550	8424.90.90	7899144813552
25	1220962	<b>CABO DO REGISTRO LP 601</b> TRIGGER VALVE HANDLE LP 601 CABO DEL REGISTRO LP 601 POIGNÉE DU ROBINET LP 601		5	PJH, PJ, XP, HD, PJB-C, PJB, DJB	8424.90.90	7909436924115
26	1220966	<b>PINÇA LP 601</b> CLIP LP 601 PINZA LP 601 FERMETURE LP 601		20	PJH, PJ, XP, HD, PJB-C, PJB, DJB	3926.90.90	7909436924474
27	1220968	<b>CORPO DO REGISTRO LP 601</b> TRIGGER VALVE BODY LP 601 CUERPO DEL REGISTRO LP 601 CORPS DU REGISTRE LP 601		5	PJH, PJ, XP, HD, PJB-C, PJB, DJB	8481.90.90	7909436924603
28	1220951	<b>ALAVANCA DO REGISTRO LP 601</b> TRIGGER VALVE LEVER LP 601 PALANCA DEL REGISTRO LP 601 LEVIER DU ROBINET LP 601		20	PJH, PJ, XP, HD, PJB-C, PJB, DJB	8424.90.90	7909436923989
29	996058	<b>TAMPA DO REGISTRO LP 601/605 COM VEDAÇÃO</b> TRIGGER VALVE CAP LP 601/ 605 AND SEAL TAPA DEL REGISTRO LP 601/605 CON VEDACIÓN COUVERCLE DU ROBINET LP 601/605 AVEC JOINT		20	PJH, PJ, XP, HD, PJB-C, PJB, DJB	8481.90.90	7909436923972
30	1230971	<b>AGULHA LATÃO DO REGISTRO</b> TRIGGER VALVE NEEDLE AGUJA DEL REGISTRO AIGUILLE DU ROBINET		20	PJH, PJ, XP, HD, PJB-C, PJB, DJB	8424.90.90	7896660860046
31	1217605	<b>REGISTRO COMPLETO LP 601</b> TRIGGER VALVE LP 601 REGISTRO COMPLETO LP 601 ROBINET COMPLÈTE LP 601		20	PJH, PJ, XP, HD, PJB-C, PJB, DJB	8481.80.99	7896660870397
32	1220972	<b>JUNTA CÔNICA</b> CONE PACKING JUNTA CÔNICA CONE PACKING		20	PJ, PJH, XP, HD, PJBC, PJB	3926.90.90	7909436925037

Nº	CÓDIGO CODE	DESCRIÇÃO DESCRIPTION DESCRIPCIÓN	IMAGEM IMAGE IMAGEN	QT. QTY. CT.	UTILIZAÇÃO UTILIZATION UTILIZACIÓN UTILISER	NCM HS CODE	EAN BARCODE
33	1220969	PORCA CÔNICA 11/16 SCREW CAP 11/16 TUERCA CONICA 11/16 ECROU CONIQUE 11/16		10	PJH, PJ, XP, HD, PJB-C, PJB, DJB	3926.90.90	7909436924924
34	100131	TUBO DE PULVERIZAÇÃO STAINLESS STEEL LANCE TUBO DE PULVERIZACIÓN TUBE DE PULVÉRISATION		1	PJH, PJ, XP, HD, PJB-C, PJB, DJB	8424.90.90	7896821501252
35	635276	JUNÇÃO E JUNTA CÔNICA JOINT AND CONE PACKING UNIÓN CON JUNTA CÔNICA JOINT AND CONE PACKING		10	PJH, PJ, XP, HD, PJB-C, PJB, DJB	3917.40.90	7909436931311
36	1168545	FILTRO DO BICO M50/60 NOZZLE FILTER M50/60 FILTRO DE LA BOQUILLA M50/60 FILTRE DE LA BUSE M50/60		20	PJH, PJ, XP, HD, PJB-C, PJB, DJB	8424.90.90	7896660860053
37	1168547	BICO JD 12 JD 12 NOZZLE BOQUILLA JD 12 BUSE JD 12		50	PJH, PJ, XP, HD, PJB-C, PJB, DJB	8424.90.90	7909436924856
38	1168546	CAPA DO BICO NOZZLE CAP CAPA DE LA BOQUILLA COUVERCLE DE LA BUSE		30	PJH, PJ, XP, HD, PJB-C, PJB, DJB	8424.90.90	7909436925310
38	915769	LANÇA COMPLETA LANCE AND TRIGGER VALVE LANZA COMPLETA LANCE COMPLÈTE		10	PJH, PJ, XP, HD, PJB-C, PJB, DJB	8424.90.90	7909436917605

## PEÇAS OPCIONAIS JACTO HD/







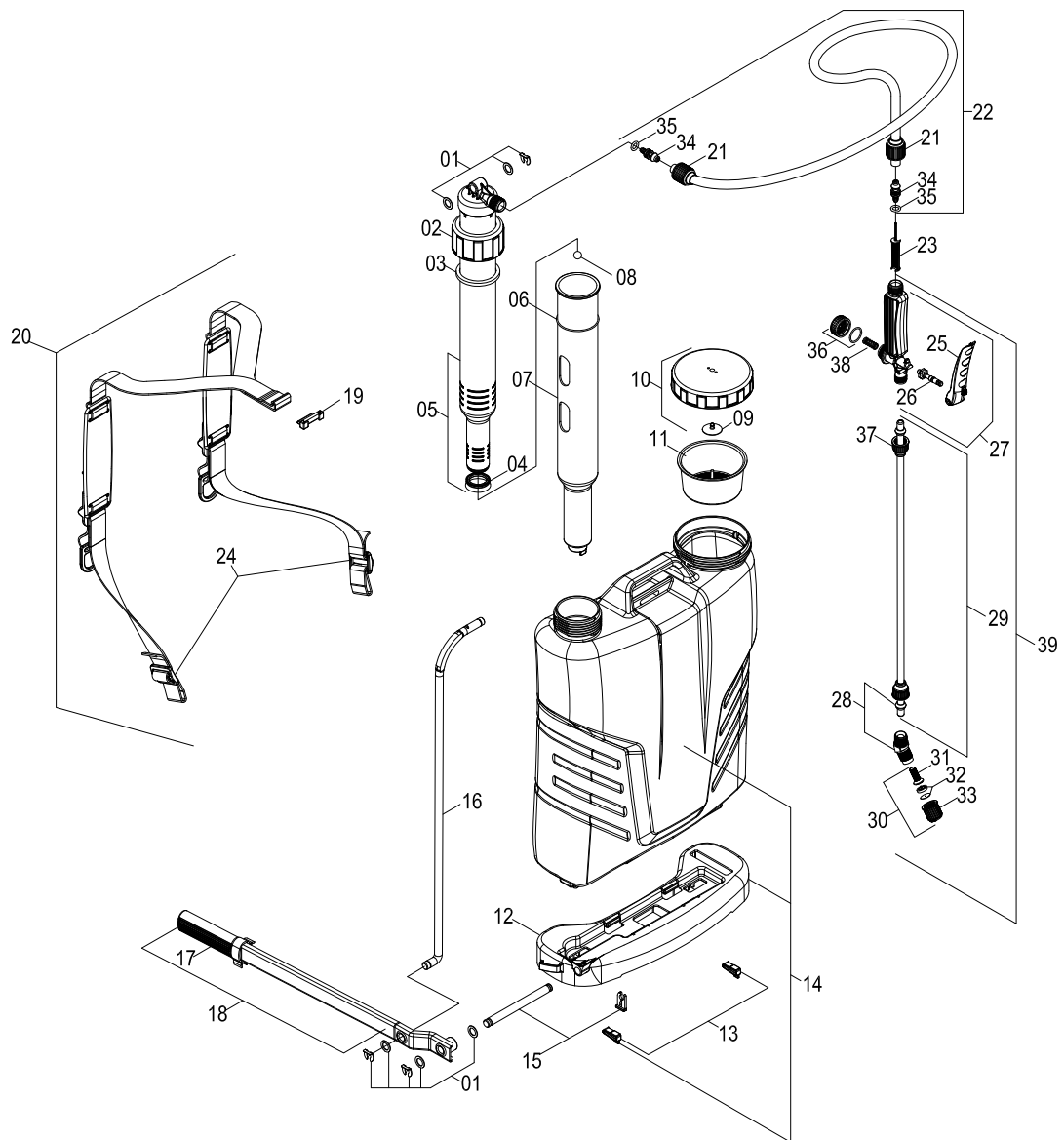







OPTIONAL PARTS JACTO HD/ PIEZAS OPCIONALES JACTO HD/ PIECES EN OPTION JACTO HD

Nº	CÓDIGO CODE	DESCRIÇÃO DESCRIPTION DESCRIPCIÓN	IMAGEM IMAGE IMAGEN	QT. QTY. CT.	UTILIZAÇÃO UTILIZATION UTILIZACIÓN UTILISER	NCM HS CODE	EAN BARCODE
1	336412	MOLA DA VÁLVULA DO CILINDRO CYLINDER VALVE SPRING MUELLE DE LA VALVULA DEL CILINDRO RESSORT DU SOUPAPE DU CYLINDRE		1	HD	7320.20.10	7899144805311
2	570945	SEDE DA ESFERA BALL SEAT SEDE DE LA ESFERA SIÈGE DE BILLE		1	HD	8424.90.90	7896821555262
3	635615	BASE DA VÁLVULA VALVE BASE BASE DE LA VALVULA BASE DU SOUPAPE		1	HD	8424.90.90	7896821559994
4	838011	VALVULA DO CILINDRO COMPLETA CYLINDER VALVE ASSEMBLY VALVULA DEL CILINDRO COMPLETA		1	HD	8481.30.00	7899144858089
5	654939	CILINDRO COMPLETO COM VÁLVULA CYLINDER ASSEMBLY WITH VALVE CILINDRO COMPLETO CON VALVULA CYLINDRE COMPLÈTE AVEC VALVE		1	HD	8424.90.90	7896821554043
6	635813	CÂMARA COMPLETA COM ÊMBOLO DE VITON CHAMBER ASSEMBLY WITH VITON PISTON CUP CAMARA COMPLETA CON EMBOLO DE VITON CHAMBRE COMPLÈTE AVEC PISTON VITON		1	HD	8424.90.90	7899144857136
7	1256384	CINTA ALMOFADADA COM REGULAGEM HD-400 PADDED STRAP BELT WITH ADJUSTMENT HD-400 CONJUNTO DE CORREA ACOLCHADA CON REGULACIÓN HD-400 COURROIE DE PADDLE AVEC RÉGULATION HD-400		1	HD-400	8424.90.90	7909436922777
8	288951	CINTA ALMOFADADA COM REGULAGEM HD-550 PADDED STRAP BELT WITH ADJUSTMENT HD-550 CONJUNTO DE CORREA ACOLCHADA CON REGULACIÓN HD-550 COURROIE DE PADDLE AVEC RÉGULATION HD-550		1	HD-550	8424.90.90	7899144879497

# JACTO XP





Nº	CÓDIGO CODE	DESCRIÇÃO DESCRIPTION DESCRIPCIÓN	IMAGEM IMAGE IMAGEN	QT. QTY. CT.	UTILIZAÇÃO UTILIZATION UTILIZACIÓN UTILISER	NCM HS CODE	EAN BARCODE
1	1198800	JOGO DE ARRUELAS E ANÉIS TRAVAS WASHERS AND LOCKED RINGS SET JUEGO DE ARANDELA Y ANILLO TRABA JEU DE RONDELLES ET BOULONS		10	PJ, PJH, XP, HD	7318.22.00	17896660843022
2	1210725	PORTA GAXETA XP GASKET HOLDER XP PORTA PRENSAESTOPA XP PORTE-JOINT XP		10	XP	8424.90.90	7909436921213
3	1168409	GAXETA DE FELTRO XP GASKET XP PRENSAESTOPA XP JOINT XP		1	XP	4016.93.00	7899144896142
4	1168407	ÊMBOLO XP (SANTOPRENE) PISTON CUP XP (SANTOPRENE) EMBOLO XP (SANTOPRENE) PISTON XP (SANTOPRENE)		20	XP	4016.99.90	7909436915229
5	1168406	CÂMARA XP C/ ÊMBOLO CHAMBER XP AND PISTON CUP CÂMARA CON EMBOLO XP CHAMBRE XP AVEC PISTON		1	XP	8424.90.90	7899144896128
6	1168404	ANEL DO CILINDRO ORI-35 O-RING ORI-35 ANILLO DEL CILINDRO ORI-35 JOINT ROND ORI-035		20	XP	4016.93.00	7909436913706
7	1168405	CILINDRO XP CYLINDER XP CYLINDRE XP		1	XP	8424.90.90	7899144896104
8	1168410	ESFERAS DE AÇO INOX STAINLESS STEEL SPHERE ESFERA DE ACERO BILLE EN ACIER INOXYDABLE		2	XP	8482.91.19	7899144896159
9	1168542	DIAFRAGMA DA TAMPA (NITRÍLICA) LID DIAPHRAGM (NITRILE) DIAFRAGMA DE LA TAPA (NITRILE) DIAPHRAGM DE LA COUVERCLE (NITRILE)		50	PJH, PJ, XP, HD, PJB-C, PJB, DJB	4016.99.90	7909436909006
10	1210726	TAMPA XP C/ DIAFRAGMA LID XP WITH DIAPHRAGM TAPA XP CON DIAFRAGMA COUVERCLE XP AVEC DIAPHRAGME		1	XP, PJB-8C	8424.90.90	7896660881898
11	1168414	COADOR XP STRAINER XP COLADOR XP TAMIS XP		1	XP, PJB-8C	8424.90.90	7899144896166
12	1210727	BASE XP TANK BASE XP BASE DU RÉSERVOIR		1	XP	8424.90.90	7896660890692
13	1168397	TRAVAS DA BASE XP BASE LOCK XP TRABA DE BASE XP LOQUET DE LA BASE		20	XP, PJB-C, PJB, DJB	8424.90.90	7909436921411
14	1210740	DEPÓSITO XP-12 C/ BASE E TRAVAS TANK XP-12 WITH BASE AND LOCK DEPÓSITO XP-12 CON BASE Y TRABAS RÉSERVOIR XP-12 AVEC BASE ET GOUPPILES		1	XP-12	8424.90.90	7896660852850
14A	1210741	DEPÓSITO XP-16 C/ BASE E TRAVAS TANK XP-16 WITH BASE AND LOCK DEPÓSITO XP-16 CON BASE Y TRABAS RÉSERVOIR XP-16 AVEC BASE ET GOUPPILES		1	XP-16	8424.90.90	7896660882666
14B	1210742	DEPÓSITO XP-20 C/ BASE E TRAVAS TANK XP-20 WITH BASE AND LOCK DEPÓSITO XP-20 CON BASE Y TRABAS RÉSERVOIR XP-20 AVEC BASE ET GOUPPILES		1	XP-20	8424.90.90	7896660852867
15	883108	EIXO DA ALAVANCA COM CANAL E TRAVA SHAFT WITH LOCK EJE CON TRABA ESSIEU AVEC BASE E GOUPPILES		1	XP, HD, PJ	8424.90.90	7896821581599

Nº	CÓDIGO CODE	DESCRIÇÃO DESCRIPTION DESCRIPCIÓN	IMAGEM IMAGE IMAGEN	QT. QTY. CT.	UTILIZAÇÃO UTILIZATION UTILIZACIÓN UTILISER	NCM HS CODE	EAN BARCODE
16	1197400	HASTE LARANJA COM TRAVAS ROD WITH LOCK HASTE CON TRABA TIGE D'OPÉRATION		1	PJ, PJH, XP, HD	8424.90.90	7896660836980
17	495812	MANOPLA DA ALAVANCA COM TRAVA HANDGRIP WITH LOCK MANIJA CON TRABA MANETTE COMPLETE		1	PJ, PJH, XP, HD	8424.90.90	7896821573990
18	615005	ALAVANCA ACIONAMENTO PUMPING LEVER PALANCA CON MANIJA LEVIER AVEC GANTELET		1	PJ, PJH, XP, HD	8424.90.90	7896821509753
19	1222671	TRAVA DA CINTA STRAP LOCK TRABA DE LA CINTA LOQUET DE LA COURROIE		5	XP, HD	8424.90.90	7909436914642
20	1168400	CINTA COMPLETA C/ REGULAGEM XP STRAP ASSEMBLY WITH ADJUSTMENT XP CINTA COMPLETA CON REGULADOR XP BRETELLE COMPLÈTE RÉGLABLE XP		1	XP	8424.90.90	7899144898771
21	942193	PORCA S20 X 1,5 SCREW CAP S20 X 1,5 TUERCA S20 X 1,5 ÉCROU S20 X 1,5		10	PJH, PJ, XP, HD, PJB-C, PJB, DJB	3926.90.90	7896821551912
22	1168403	MANGUEIRA COMPLETA P/ LP 603 HOSE ASSEMBLY XP FOR LP 603 MANGUERA COMPLETA P/ LP 603 TUYAU COMPLET LP603		5	XP	3917.39.00	7909436914611
23	1168418	FILTRO LP-3 FILTER LP-3 FILTRE LP-3		20	PJH, PJ, XP, HD, PJB-C, PJB, DJB	8424.90.90	7909436913560
24	502757	FIVELA STRAP BUCKLE HEBILLA BOUCLE		1	PJH, PJ, XP, HD, PJB-C, PJB, DJB	3926.90.90	7896821574768
25	1168421	ALAVANCA DO REGISTRO LP-3 TRIGGER VALVE LEVER LP-3 PALANCA DEL REGISTRO LP-3 LEVIER COMPLET LP-3		10	PJH, PJ, XP, HD, PJB-C, PJB, DJB	8424.90.90	7909436921053
26	1168422	AGULHA LP-3 C/ VEDAÇÕES NEEDLE LP-3 AND RINGS AGUJA LP-3 CON VEDACION AIGUILLE COMPLÈTE LP-3		1	PJH, PJ, XP, HD, PJB-C, PJB, DJB	8481.90.90	7899144899037
27	1168419	REGISTRO COMPLETO LP-3 TRIGGER VALVE ASSEMBLY LP-3 ROBINET COMPLÈTE LP-3		1	PJH, PJ, XP, HD, PJB-C, PJB, DJB	8481.80.99	7899144898900
28	635276	JUNÇÃO E JUNTA CÔNICA JOINT AND CONE PACKING UNIÓN CON JUNTA CÓNICA COUDE AVEC ÉTANCHÉITE CONIQUE		10	PJH, PJ, XP, HD, PJB-C, PJB, DJB	3917.40.90	7909436931311
29	100131	TUBO DE PULVERIZAÇÃO STAINLESS STEEL LANCE TUBO DE PULVERIZACIÓN TUBE DE PULVÉRISATION		1	PJH, PJ, XP, HD, PJB-C, PJB, DJB	8424.90.90	7896821501252
30	427062	BICO COMPLETO JD-12 NOZZLE JD-12 ASSEMBLY BOQUILLA COMPLETA JD-12 BUSE COMPLÈTE JD-12		20	PJH, PJ, XP, HD, PJB-C, PJB, DJB	8424.90.90	7909436928052
31	1168545	FILTRO DO BICO M50/60 NOZZLE FILTER M50/60 FILTRO DE LA BOQUILLA M50/60 FILTRE DE LA BUSE M50/60		20	PJH, PJ, XP, HD, PJB-C, PJB, DJB	8424.90.90	7896660860053
32	1168547	BICO JD 12 JD 12 NOZZLE BOQUILLA JD 12 BUSE JD 12		50	PJH, PJ, XP, HD, PJB-C, PJB, DJB	8424.90.90	7909436924856

Nº	CÓDIGO CODE	DESCRIÇÃO DESCRIPTION DESCRIPCIÓN	IMAGEM IMAGE IMAGEN	QT. QTY. CT.	UTILIZAÇÃO UTILIZATION UTILIZACIÓN UTILISER	NCM HS CODE	EAN BARCODE
33	1168546	CAPA DO BICO NOZZLE CAP CAPA DE LA BOQUILLA COUVERCLE DE LA BUSE		30	PJH, PJ, XP, HD, PJB-C, PJB, DJB	8424.90.90	7909436925310
34	942201	BICO DE SAÍDA Ø5/16" OUTLET TUBE Ø5/16" BOQUILLA DE SALIDA Ø5/16" BEC Ø5/16"		1	XP, HD	3926.90.90	7896821597941
35	231845	ORING ORI-110		1	XP, HD	4016.93.00	7896821553275
36	1168544	TAMPA DO REGISTRO C/ VEDAÇÃO TRIGGER VALVE CAP AND RING TAPA DEL REGISTRO CON VEDACION COUVERCLE DU ROBINET		10	PJH, PJ, XP, HD, PJB-C, PJB, DJB	3926.90.90	7909436921138
37	1220969	PORCA CÔNICA 11/16 SCREW CAP 11/16 TUERCA CONICA 11/16 ECROU CONIQUE 11/16		10	PJH, PJ, XP, HD, PJB-C, PJB, DJB	3926.90.90	7909436924924
38	1222660	MOLA SPRING RESORTE RESSORT		10	PJH, PJ, XP, HD, PJB-C, PJB, DJB	7320.90.00	7909436921022
39	1185540	LANÇA COMPLETA COMPLETE LANCE LANZA COMPLETA LANCE COMPLETE		1	PJH, PJ, XP, HD, PJB-C, PJB, DJB	8424.90.90	7896660831343



## PEÇAS OPCIONAIS JACTO XP/

OPTIONAL PARTS JACTO XP/ PIEZAS OPCIONALES JACTO XP/ PIECES EN OPTION JACTO XP

Nº	CÓDIGO CODE	DESCRIÇÃO DESCRIPTION DESCRIPCIÓN	IMAGEM IMAGE IMAGEN	QT. QTY. CT.	UTILIZAÇÃO UTILIZATION UTILIZACIÓN UTILISER	NCM HS CODE	EAN BARCODE
1	1176504	CINTA ALMOFADADA COMPLETA XP SOFT PADDED STRAP ASSEMBLY XP CINTA COMPLETA ACOLCHADA XP STRAP AVEC PAD XP		1	XP	8424.90.90	7896660890807









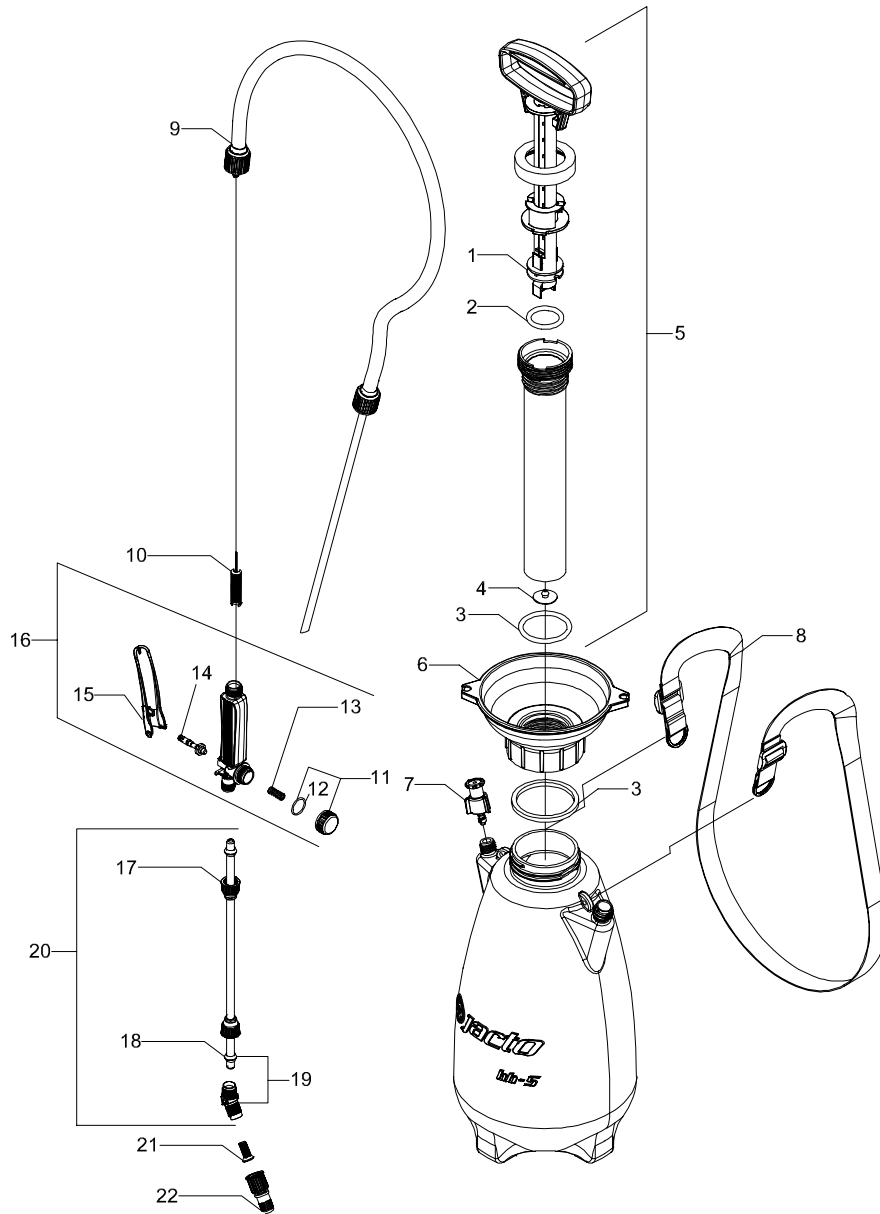





## PEÇAS JACTO XP-312 E XP-416/

OPTIONAL PARTS JACTO XP-312 AND XP-416/ PIEZAS OPCIONALES JACTO XP-312 Y XP-416/ PIECES EN OPTION JACTO XP-312 ET XP-416

Nº	CÓDIGO CODE	DESCRIÇÃO DESCRIPTION DESCRIPCIÓN	IMAGEM IMAGE IMAGEN	QT. QTY. CT.	UTILIZAÇÃO UTILIZATION UTILIZACIÓN UTILISER	NCM HS CODE	EAN BARCODE
1	1211809	DEPÓSITO XP-312 C/ BASE E TRAVAS TANK XP-312 WITH BASE AND LOCK DEPÓSITO XP-312 CON BASE Y TRABAS RÉSERVOIR XP-312 AVEC BASE ET GOUPPILES		1	XP-312	8424.90.90	
2	1211810	DEPÓSITO XP-316 C/ BASE E TRAVAS TANK XP-316 WITH BASE AND LOCK DEPÓSITO XP-316 CON BASE Y TRABAS RÉSERVOIR XP-316 AVEC BASE ET GOUPPILES		1	XP-416	8424.90.90	

# JACTO HH-5



No	CODE CÓDIGO	DESCRIPTION DESCRIPCIÓN	IMAGE IMAGEN	QTY. CT.	UTILIZATION UTILIZACIÓN UTILISER	NCM HS CODE	EAN BARCODE
1	1232054	FASTENER PISTÓN ATTACHE		1	HH-5	8424.90.90	7896660821870
2	1232050	PISTON RING ANILLO DEL PISTÓN JOINT EN BAGUE		1	HH-5	4016.93.00	7896660821795
3	1232052	SEALS SISTEMA DE VEDACIÓN SCELLÉS		1	HH-5	4016.93.00	7896660821856
4	1232057	DIAPHRAGM DIAFRAGMA DIAPHRAGME		1	HH-5	4016.93.00	7896660821894
5	1232055	PUMP ASSEMBLY CÁMARA COMPLETA POMPE COMPLÈTE		1	HH-5	8413.20.00	7896660821887
6	1232056	LID TANK TAPA COURVECLE DU RÉSERVOIR		1	HH-5	8424.90.90	7896660821788
7	1232053	PRESSURE RELIEF VALVE VÁLVULA DE SEGURIDAD SOUPAPE DE DÉCHARGE DE PRESSION		1	HH-5	8481.40.00	7896660821863
8	1232067	COMPLETE BELT CORREA COMPLETA COURROIE COMPLÈTE		1	HH-5	8424.90.90	7896660820859
9	1232058	COMPLETE HOSE FOR LP3 MANGUERA LP3 TUYAU COMPLET POUR LP3		1	HH-5	8424.90.90	7896660821917
10	1168418	FILTER LP-3 FILTRE LP-3		20	PJH, PJ, XP, HD, PJB-C, PJB, DJB	8424.90.90	7909436913560
11	1168544	TRIGGER VALVE CAP AND SEAL TAPA DEL REGISTRO CON VEDACION COUVERCLE DU ROBINET		10	PJH, PJ, XP, HD, PJB-C, PJB, DJB	3926.90.90	7909436921138
12	1220934	ORING ORI-19		10	PJH, PJ, XP, HD, PJB-C, PJB, DJB	4016.93.00	7909436906784
13	1222660	SPRING RESORTE RESSORT		10	PJH, PJ, XP, HD, PJB-C, PJB, DJB	7320.90.00	7909436921022
14	1168422	NEEDLE LP-3 AND RINGS AGUJA LP-3 CON VEDACION AIGUILLE COMPLÈTE LP-3		1	PJH, PJ, XP, HD, PJB-C, PJB, DJB	8481.90.90	7899144899037
15	1168421	TRIGGER VALVE LEVER LP-3 PALANCA DEL REGISTRO LP-3 LEVIER COMPLET LP-3		10	PJH, PJ, XP, HD, PJB-C, PJB, DJB	8424.90.90	7909436921053
16	1168419	TRIGGER VALVE ASSEMBLY LP-3 ROBINET COMPLÈTE LP-3		1	PJH, PJ, XP, HD, PJB-C, PJB, DJB	8481.80.99	7899144898900
17	1220969	SCREW CAP 11/16 TUERCA CONICA 11/16 ECROU CONIQUE 11/16		10	PJH, PJ, XP, HD, PJB-C, PJB, DJB	3926.90.90	7909436924924

# JACTO HH-5

No	CODE CÓDIGO	DESCRIPTION DESCRIPCIÓN	IMAGE IMAGEN	QTY. CT.	UTILIZATION UTILIZACIÓN UTILISER	NCM HS CODE	EAN BARCODE
18	1220972	<b>CONE PACKING</b> JUNTA CÓNICA CONE PACKING		20	PJ, PJH, XP, HD, PJBC, PJB	3926.90.90	7909436925037
19	635276	<b>JOINT AND CONE PACKING</b> UNIÓN CON JUNTA CÓNICA JOINT AND CONE PACKING		10	PJH, PJ, XP, HD, PJB-C, PJB, DJB	3917.40.90	7909436931311
20	1224677	<b>LANCE PJB-8C COMPLETE</b> TUBO COMPLETO DE LA LANZA LANCE PJB-8C COMPLÈTE		1	HH-5, PJB-8C	8424.90.90	7896660896007
21	1168545	<b>NOZZLE FILTER M50/60</b> FILTRO DE LA BOQUILLA M50/60 FILTRE DE LA BUSE M50/60		20	PJH, PJ, XP, HD, PJB-C, PJB, DJB	8424.90.90	7896660860053
22	1222664	<b>BLUE ADJUSTABLE CONE NOZZLE</b> BOQUILLA CÓNICO AJUSTABLE AZUL BUSE CÔNE RÉGLABLE BLEU		10	PJ, PJH, XP, HD, PJBC, PJB, DJB	8424.90.90	7909436928588



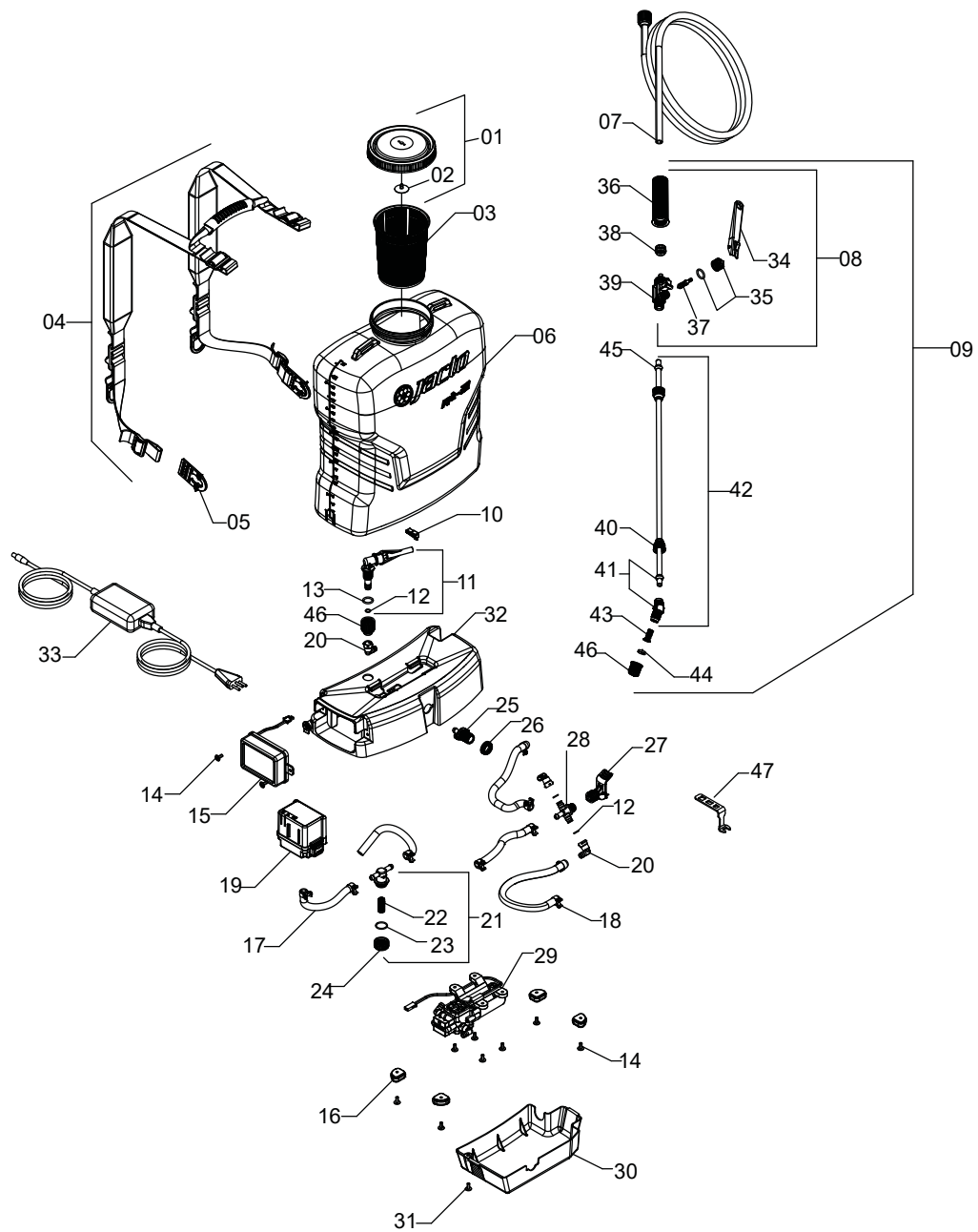













# JACTO PJB

















# JACTO PJB

Nº	CÓDIGO CODE	DESCRIÇÃO DESCRIPTION DESCRIPCIÓN	IMAGEM IMAGE IMAGEN	QT. QTY. CT.	UTILIZAÇÃO UTILIZATION UTILIZACIÓN UTILISER	NCM HS CODE	EAN BARCODE
1	1220918	TAMPA COM DIAFRAGMA LID WITH DIAPHRAGM TAPA CON DIAFRAGMA COUVERCLE AVEC DIAPHRAGM		1	PJ, HD, PJB-C, PJB, DJB	8424.90.90	7896660888286
2	1168542	DIAFRAGMA DA TAMPA (NITRÍLICA) LID DIAPHRAGM (NITRILE) DIAFRAGMA DE LA TAPA (NITRILE) DIAPHRAGM DE LA COUVERCLE (NITRILE)		50	PJH, PJ, XP, HD, PJB-C, PJB, DJB	4016.99.90	7909436909006
3	1220919	COADOR TANK STRAINER COLADOR TAMIS		1	PJ, HD, PJB-C, PJB, DJB	8424.90.90	7896660888309
4	1220618	CINTA COMPLETA COM ALÇA COMPLETE BELT WITH HANDLE CINTA COMPLETA COM ALZA COURROIE COMPLÈTE AVEC POIGNÉE		1	PJB-C, PJB, DJB	8424.90.90	7896660888316
5	1220973	FIVELA DA CINTA BUCKLE HEBILLA BOUCLE		2	HD, PJB-C, PJB, DJB	8424.90.90	7909436915274
6	1220619	CORPO DO DEPÓSITO 20L TANK BODY 20L CUERPO DEL TANQUE 20L RÉSERVOIR 20L		1	PJB-20	8424.90.90	7896660888330
6A	1223765	CORPO DO DEPÓSITO 16L TANK 16L CUERPO DEL TANQUE 16L RÉSERVOIR 16L		1	PJB-16	8424.90.90	7896660864907
7	1220981	MANGUEIRA COMPLETA P/ LP 605 E LP 601 COMPLETE HOSE FOR LP 605 AND LP 601 MANGUERA COMPLETA P/ LP 605 Y LP 601 TUYAU COMPLET LP 605 ET LP 601		1	PJB-C, PJB, DJB	8424.90.90	7896660888347
8	1217605	REGISTRO COMPLETO LP 601 TRIGGER VALVE LP 601 REGISTRO COMPLETO LP 601 ROBINET COMPLÈTE LP 601		20	PJH, PJ, XP, HD, PJB-C, PJB, DJB	8481.80.99	7896660870397
9	915769	LANÇA COMPLETA LANCE AND TRIGGER VALVE LANZA COMPLETA LANCE COMPLÈTE		10	PJH, PJ, XP, HD, PJB-C, PJB, DJB	8424.90.90	7909436924573
10	1168397	TRAVA DA BASE BASE LOCK GRAPA DE LA BASE LOQUET DE LA BASE		20	XP, PJB-C, PJB, DJB	8424.90.90	7909436921411
11	1220977	AGITADOR COMPLETO AGITATOR ASSEMBLY AGITADOR COMPLETO AGITATEUR COMPLET		1	PJB, DJB	8424.90.90	7896660888385
12	1220629	ANEL O-RING OR1-11 O-RING OR1-11 ANILLO O-RING OR1-11 ANNEAU O-RING OR1-11		10	PJB, DJB	4016.93.00	7909436917971
13	1223766	VEDAÇÃO DO AGITADOR AGITATOR SEAL SELLADO DEL AGITADOR JOINTS DE L'AGITATEUR		10	PJB, DJB	4016.93.00	7909436920612
14	1220622	PARAF. CAB. FLANG. PH 5 X 12 MM FLANGE HEAD SCREW PHILLIPS SLOT 5 X 12 MM TORNILLO PH 5 X 12 MM VIS DE TÊTE FLANGE 5 X 12 MM		10	PJB, DJB	7318.15.00	7909436907286
15	1220623	PAINEL ELÉTRICO PJB ELECTRIC PANEL PJB CUADRO ELÉCTRICO PJB TABLEAU ELECTRIQUE PJB		1	PJB	8424.90.90	7896660888422
16	1220624	KIT PÉS DE BORRACHA RUBBER FEET KIT KIT PIES DE GOMA KIT PIEDS EN CAOUTCHOUC		4	PJB, DJB	4016.99.90	7896660888439









Nº	CÓDIGO CODE	DESCRIÇÃO DESCRIPTION DESCRIPCIÓN	IMAGEM IMAGE IMAGEN	QT. QTY. CT.	UTILIZAÇÃO UTILIZATION UTILIZACIÓN UTILISER	NCM HS CODE	EAN BARCODE
17	1220625	<b>KIT MANGUEIRAS</b> HOSE KIT KIT MANGUERAS KIT DES TUYAUX		5	PJB, DJB	3917.31.00	7896660888194
18	1220925	<b>ABRAÇADEIRA</b> CLAMP ABRAZADERA COLLIER		10	PJB-C, PJB, DJB	7326.90.90	7909436923484
19	1220628	<b>BATERIA JB 1660</b> BATTERY JB 1660 BATERIA JACTO JB 1660 BATTERIE JB 1660		1	PJB, DJB	8507.60.00	7896660888514
20	1220631	<b>CONECTOR 3/8</b> SWIVEL CONNECTOR 3/8 UNIÓN 3/8 COUDE 3/8		3	PJB, DJB	3917.40.90	7909436922692
21	1220632	<b>KIT FILTRO DA BOMBA PJB</b> PJB PUMP FILTER KIT KIT FILTRO DE LA BOMBA PJB KIT FILTRE DE LA POMPE PJB		1	PJB-C, PJB, DJB	8421.29.90	7896660888538
22	1220634	<b>FILTRO DE LINHA</b> INLINE FILTER FILTRO DE LINEA FILTRE DE LIGNE		10	PJB-C, PJB, DJB	8421.29.90	7909436907125
23	1220934	<b>ANEL O 20,34 1,78 NITR 70 ORI-19</b> O-RING 20.34 1.78 NITR 70 ORI-19 ANILLO O 20,34 1,78 NITR 70 ORI-19 ANNEAU O 20,34 1,78 NITR 70 ORI-19		10	PJH, PJ, XP, HD, PJB-C, PJB, DJB	4016.93.00	7909436906784
24	1168544	<b>TAMPA DO REGISTRO C/ VEDAÇÃO</b> FILTER COVER CAP AND O-RING TAPA DEL REGISTRO CON SELLADO COUVERCLE DU REGISTRE AVEC JOINT		10	PJH, PJ, XP, HD, PJB-C, PJB, DJB	3926.90.90	7909436921138
25	1220635	<b>CONECTOR DA MANGUEIRA</b> HOSE CONNECTOR CONECTOR DE LA MANGUERA CONNECTEUR DU TUYAU		5	PJH, PJ, XP, HD, PJB-C, PJB, DJB	3926.90.90	7896660873985
26	1220636	<b>PORCA DO CONECTOR</b> CONNECTOR NUT TUERCA DEL CONECTOR ECROU DU CONNECTEUR		5	PJH, PJ, XP, HD, PJB-C, PJB, DJB	3926.90.90	7896660873992
27	1220979	<b>ALAVANCA DO AGITADOR E AGULHA</b> AGITATOR LEVER AND NEEDLE ASSEMBLY AGUJA Y PALANCA DEL AGITADOR AIGUILLE ET LEVIER DU AGITATEUR		1	PJB, DJB	8424.90.90	7896660890258
28	1220638	<b>CORPO DA VÁLVULA DO AGITADOR</b> AGITATOR VALVE BODY CUERPO DE LA VALVULA DEL AGITADOR CORPS DE LA VALVULE DU AGITATEUR		1	PJB, DJB	3926.90.90	7896660890265
29	1220639	<b>BOMBA JP 0402X</b> PUMP JP 0402X BOMBA JP 0402X POMPE JP 0402X		1	PJB-C, PJB, DJB	8413.50.90	7896660890272
30	1220640	<b>TAMPA DA BASE</b> BASE COVER TAPA DE LA BASE COUVERCLE DE LA BASE		1	PJB-C, PJB, DJB	8424.90.90	7896660890289
31	1220947	<b>PARAF CAB.PAN.PH M 5X0,8X 12</b> PAN HEAD SCREW PHILLIPS SLOT M 5X0,8X12 TORNILLO PH M 5X0,8X 12 VIS TÊTE RONDE M 5X0,8X 12		10	PJB-C, PJB, DJB	7318.15.00	7909436907354
32	1220641	<b>BASE DO PULVERIZADOR ELÉTRICO</b> ELECTRIC SPRAYER BASE BASE DEL PULVERIZADOR ELÉCTRICO BASE DU PULVÉRIZATEUR ÉLECTRIQUE		1	PJB-C, PJB, DJB	8424.90.90	7896660890302
33	1223781	<b>CARREGADOR COM PLUG TIPO C</b> PLUG TYPE C CHARGER CARGADOR CON PLUG TIPO C CHARGEUR TYPE C		1	PJB, DJB	8504.40.10	7896660894133

# JACTO PJB

Nº	CÓDIGO CODE	DESCRIÇÃO DESCRIPTION DESCRIPCIÓN	IMAGEM IMAGE IMAGEN	QT. QTY. CT.	UTILIZAÇÃO UTILIZATION UTILIZACIÓN UTILISER	NCM HS CODE	EAN BARCODE
34	1220951	ALAVANCA DO REGISTRO LP 601 TRIGGER VALVE LEVER LP 601 PALANCA DEL REGISTRO LP 601 LEVIER DU ROBINET LP 601		20	PJH, PJ, XP, HD, PJB-C, PJB, DJB	8424.90.90	7909436923989
35	996058	TAMPA DO REGISTRO LP 601/605 COM VEDAÇÃO TRIGGER VALVE CAP LP 601/ 605 AND SEAL TAPA DEL REGISTRO LP 601/605 CON VEDACIÓN COUVERCLE DU ROBINET LP 601/605 AVEC JOINT		20	PJH, PJ, XP, HD, PJB-C, PJB, DJB	8481.90.90	7909436923972
36	1220962	CABO DO REGISTRO LP 601 TRIGGER VALVE HANDLE LP 601 CABO DEL REGISTRO LP 601 POIGNÉE DU ROBINET LP 601		5	PJH, PJ, XP, HD, PJB-C, PJB, DJB	8424.90.90	7909436924115
37	1230971	AGULHA LATÃO DO REGISTRO TRIGGER VALVE NEEDLE AGUJA DEL REGISTRO AIGUILLE DU ROBINET		20	PJH, PJ, XP, HD, PJB-C, PJB, DJB	8424.90.90	7896660860046
38	1220966	PINÇA LP 601 CLIP LP 601 PINZA LP 601 FERMETURE LP 601		20	PJH, PJ, XP, HD, PJB-C, PJB, DJB	3926.90.90	7909436924474
39	1220968	CORPO DO REGISTRO LP 601 TRIGGER VALVE BODY LP 601 CUERPO DEL REGISTRO LP 601 CORPS DU REGISTRE LP 601		5	PJH, PJ, XP, HD, PJB-C, PJB, DJB	8481.90.90	7909436924603
40	1220969	PORCA CÔNICA 11/16 SCREW CAP 11/16 TUERCA CONICA 11/16 BOULON CONIQUE 11/16		10	PJH, PJ, XP, HD, PJB-C, PJB, DJB	3926.90.90	7909436924924
41	635276	JUNÇÃO E JUNTA CÔNICA JOINT AND CONE PACKING UNIÓN CON JUNTA CÔNICA JOINT AND CONE PACKING		10	PJH, PJ, XP, HD, PJB-C, PJB, DJB	3917.40.90	7909436931311
42	100131	TUBO DE PULVERIZAÇÃO STAINLESS STEEL LANCE TUBO DE PULVERIZACIÓN TUBE DE PULVÉRISATION		1	PJH, PJ, XP, HD, PJB-C, PJB, DJB	8424.90.90	7896821501252
43	1168545	FILTRO DO BICO M50/60 NOZZLE FILTER M50/60 FILTRO DE LA BOQUILLA M50/60 FILTRE DE LA BUSE M50/60		20	PJH, PJ, XP, HD, PJB-C, PJB, DJB	8424.90.90	7896660860053
44	1168547	BICO JD 12 JD 12 NOZZLE BOQUILLA JD 12 BUSE JD 12		50	PJH, PJ, XP, HD, PJB-C, PJB, DJB	8424.90.90	7909436924856
45	1220972	JUNTA CÔNICA CONE PACKING JUNTA CONICA JOINT CONIQUE		20	PJH, PJ, XP, HD, PJB-C, PJB, DJB	3926.90.90	7909436925037
46	1168546	CAPA DO BICO NOZZLE CAP CAPA DE LA BOQUILLA COUVERCLE DE LA BUSE		30	PJH, PJ, XP, HD, PJB-C, PJB, DJB	8424.90.90	7909436925310
47	1223850	CHAVE DE MANUTENÇÃO PJB PJB MAINTENANCE KEY LLAVE DE MANTENIMINETO PJB CLÉ ENTRETIEN PJB		1	PJB, DJB	8204.11.00	7896660894676









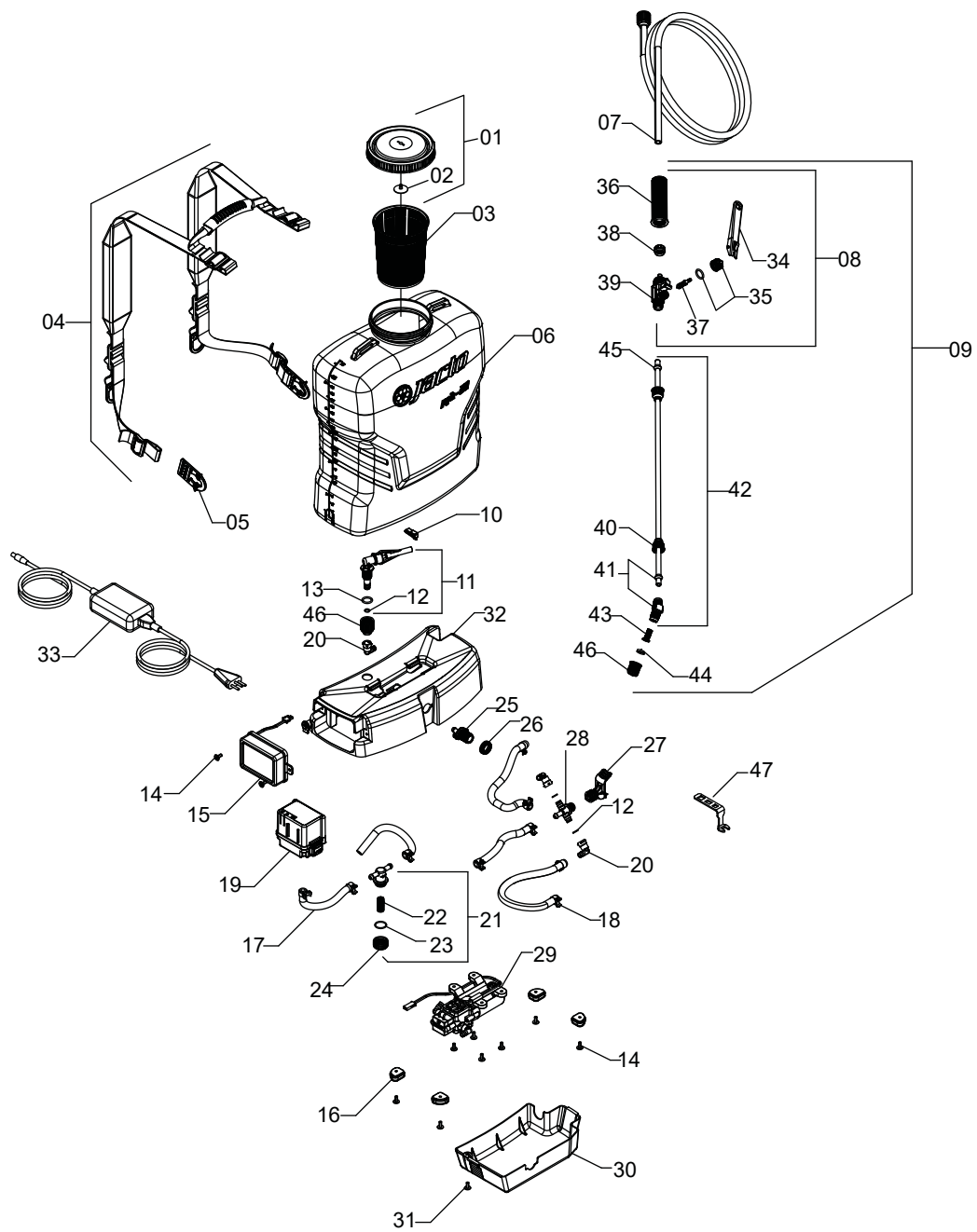



## PEÇAS OPCIONAIS JACTO PJB/

















OPTIONAL PARTS JACTO PJB/ PIEZAS OPCIONALES JACTO PJB/ PIECES EN OPTION JACTO PJB













Nº	CÓDIGO CODE	DESCRIÇÃO DESCRIPTION DESCRIPCIÓN	IMAGEM IMAGE IMAGEN	QT. QTY. CT.	UTILIZAÇÃO UTILIZATION UTILIZACIÓN UTILISER	NCM HS CODE	EAN BARCODE
1	1223797	CARREGADOR COM PLUG TIPO A PLUG TYPE A CHARGER CARGADOR CON PLUG TIPO A CHARGEUR TYPE A		1	PJB, DJB	8504.40.10	7896660894140
2	1223798	CARREGADOR COM PLUG TIPO B PLUG TYPE B CHARGER CARGADOR CON PLUG TIPO B CHARGEUR TYPE B		1	PJB, DJB	8504.40.10	7896660894171
3	1223793	CARREGADOR COM PLUG TIPO F PLUG TYPE F CHARGER CARGADOR CON PLUG TIPO F CHARGEUR TYPE F		1	PJB, DJB	8504.40.10	7896660894157
4	1220642	CARREGADOR COM PLUG TIPO N PLUG TYPE N CHARGER CARGADOR CON PLUG TIPO N CHARGEUR TYPE N		1	PJB, DJB	8504.40.10	7896660890319
5	1245614	CARREGADOR COM PLUG TIPO G PLUG TYPE G CHARGER CARGADOR CON PLUG TIPO G CHARGEUR TYPE G		1	PJB, DJB	8504.40.10	7909436901826
6	1255166	CARREGADOR COM PLUG TIPO I PLUG TYPE I CHARGER CARGADOR CON PLUG TIPO I CHARGEUR TYPE I		1	PJB, DJB	8504.40.10	7909436920827

# JACTO DJB



Nº	CÓDIGO CODE	DESCRIÇÃO DESCRIPTION DESCRIPCIÓN	IMAGEM IMAGE IMAGEM	QT. QTY. CT.	UTILIZAÇÃO UTILIZATION UTILIZACIÓN UTILISER	NCM HS CODE	EAN BARCODE
1	1220918	TAMPA COM DIAFRAGMA LID WITH DIAPHRAGM TAPA CON DIAFRAGMA COUVERCLE AVEC DIAPHRAGM		1	PJ, HD, PJB-C, PJB, DJB	8424.90.90	7896660888286
2	1168542	DIAFRAGMA DA TAMPA (NITRÍLICA) LID DIAPHRAGM (NITRILE) DIAFRAGMA DE LA TAPA (NITRILE) DIAPHRAGM DE LA COUVERCLE (NITRILE)		50	PJH, PJ, XP, HD, PJB-C, PJB, DJB	4016.99.90	7909436909006
3	1220919	COADOR TANK STRAINER COLADOR TAMIS		1	PJ, HD, PJB-C, PJB, DJB	8424.90.90	7896660888309
4	1220618	CINTA COMPLETA COM ALÇA COMPLETE BELT WITH HANDLE CINTA COMPLETA COM ALZA COURROIE COMPLÈTE AVEC POIGNÉE		1	PJB-C, PJB, DJB	8424.90.90	7896660888316
5	1220973	FIVELA DA CINTA BUCKLE HEBILLA BOUCLE		2	HD, PJB-C, PJB, DJB	8424.90.90	7909436915274
6	1220619	CORPO DO DEPÓSITO 20L TANK BODY 20L CUERPO DEL TANQUE 20L RÉSERVOIR 20L		1	PJB-20	8424.90.90	7896660888330
7	1220981	MANGUEIRA COMPLETA P/ LP 605 E LP 601 COMPLETE HOSE FOR LP 605 AND LP 601 MANGUERA COMPLETA P/ LP 605 Y LP 601 TUYAU COMPLET LP 605 ET LP 601		1	PJB-C, PJB, DJB	8424.90.90	7896660888347
8	1217605	REGISTRO COMPLETO LP 601 TRIGGER VALVE LP 601 REGISTRO COMPLETO LP 601 ROBINET COMPLÈTE LP 601		20	PJH, PJ, XP, HD, PJB-C, PJB, DJB	8481.80.99	7896660870397
9	915769	LANÇA COMPLETA LANCE AND TRIGGER VALVE LANZA COMPLETA LANÇE COMPLÈTE		10	PJH, PJ, XP, HD, PJB-C, PJB, DJB	8424.90.90	7909436924573
10	1168397	TRAVA DA BASE BASE LOCK GRAPA DE LA BASE LOQUET DE LA BASE		20	XP, PJB-C, PJB, DJB	8424.90.90	7909436921411
11	1220977	AGITADOR COMPLETO AGITATOR ASSEMBLY AGITADOR COMPLETO AGITATEUR COMPLET		1	PJB, DJB	8424.90.90	7896660888385
12	1220629	ANEL O-RING ORI-11 O-RING ORI-11 ANILLO O-RING ORI-11 ANNEAU O-RING ORI-11		10	PJB, DJB	4016.93.00	7909436917971
13	1223766	VEDAÇÃO DO AGITADOR AGITATOR SEAL SELLADO DEL AGITADOR JOINTS DE L'AGITATEUR		10	PJB, DJB	4016.93.00	7909436920612
14	1220622	PARAF. CAB. FLANG. PH 5 X 12 MM FLANGE HEAD SCREW PHILLIPS SLOT 5 X 12 MM TORNILLO PH 5 X 12 MM VIS DE TÊTE FLANGE 5 X 12 MM		10	PJB, DJB	7318.15.00	7909436907286
15	1236379	PAINEL ELÉTRICO DJB ELECTRIC PANEL DJB CUADRO ELÉCTRICO DJB TABLEAU ELECTRIQUE DJB		1	PJB	8424.90.90	7896660888422
16	1220624	KIT PÉS DE BORRACHA RUBBER FEET KIT KIT PIES DE GOMA KIT PIEDS EN CAOUTCHOUC		4	PJB, DJB	4016.99.90	7896660888439
17	1220625	KIT MANGUEIRAS HOSE KIT KIT MANGUERAS KIT DES TUYAUX		5	PJB, DJB	3917.31.00	7896660888194

Nº	CÓDIGO CODE	DESCRIÇÃO DESCRIPTION DESCRIPCIÓN	IMAGEM IMAGE IMAGEN	QT. QTY. CT.	UTILIZAÇÃO UTILIZATION UTILIZACIÓN UTILISER	NCM HS CODE	EAN BARCODE
18	1220925	ABRAÇADEIRA CLAMP ABRAZADERA COLLIER		10	PJB-C, PJB, DJB	7326.90.90	7909436923484
19	1220628	BATERIA JB 1660 BATTERY JB 1660 BATERÍA JACTO JB 1660 BATTERIE JB 1660		1	PJB, DJB	8507.60.00	7896660888514
20	1220631	CONECTOR 3/8 SWIVEL CONNECTOR 3/8 UNIÓN 3/8 COUDE 3/8		3	PJB, DJB	3917.40.90	7909436922692
21	1220632	KIT FILTRO DA BOMBA PJB PJB PUMP FILTER KIT KIT FILTRO DE LA BOMBA PJB KIT FILTRE DE LA POMPE PJB		1	PJB-C, PJB, DJB	8421.29.90	7896660888538
22	1220634	FILTRO DE LINHA INLINE FILTER FILTRO DE LINEA FILTRE DE LIGNE		10	PJB-C, PJB, DJB	8421.29.90	7909436907125
23	1220934	ANEL O 20,34 1,78 NITR 70 ORI-19 O-RING 20.34 1.78 NITR 70 ORI-19 ANILLO O 20,34 1,78 NITR 70 ORI-19 ANNEAU O 20,34 1,78 NITR 70 ORI-19		10	PJH, PJ, XP, HD, PJB-C, PJB, DJB	4016.93.00	7909436906784
24	1168544	TAMPA DO REGISTRO C/ VEDAÇÃO FILTER COVER CAP AND O-RING TAPA DEL REGISTRO CON SELLADO COUVERCLE DU REGISTRE AVEC JOINT		10	PJH, PJ, XP, HD, PJB-C, PJB, DJB	3926.90.90	7909436921138
25	1220635	CONECTOR DA MANGUEIRA HOSE CONNECTOR CONECTOR DE LA MANGUERA CONNECTEUR DU TUYAU		5	PJH, PJ, XP, HD, PJB-C, PJB, DJB	3926.90.90	7896660873985
26	1220636	PORCA DO CONECTOR CONNECTOR NUT TUERCA DEL CONECTOR ECROU DU CONNECTEUR		5	PJH, PJ, XP, HD, PJB-C, PJB, DJB	3926.90.90	7896660873992
27	1220979	ALAVANCA DO AGITADOR E AGULHA AGITATOR LEVER AND NEEDLE ASSEMBLY AGUJA Y PALANCA DEL AGITADOR AIGUILLE ET LEVIER DU AGITATEUR		1	PJB, DJB	8424.90.90	7896660890258
28	1220638	CORPO DA VÁLVULA DO AGITADOR AGITATOR VALVE BODY CUERPO DE LA VALVULA DEL AGITADOR CORPS DE LA VALVULE DU AGITATEUR		1	PJB, DJB	3926.90.90	7896660890265
29	1220639	BOMBA JP 0402X PUMP JP 0402X BOMBA JP 0402X POMPE JP 0402X		1	PJB-C, PJB, DJB	8413.50.90	7896660890272
30	1220640	TAMPA DA BASE BASE COVER TAPA DE LA BASE COUVERCLE DE LA BASE		1	PJB-C, PJB, DJB	8424.90.90	7896660890289
31	1220947	PARAF CAB.PAN.PH M 5X0,8X 12 PAN HEAD SCREW PHILLIPS SLOT M 5X0,8X12 TORNILLO PH M 5X0,8X 12 VIS TÊTE RONDE M 5X0,8X 12		10	PJB-C, PJB, DJB	7318.15.00	7909436907354
32	1220641	BASE DO PULVERIZADOR ELÉTRICO ELECTRIC SPRAYER BASE BASE DEL PULVERIZADOR ELÉCTRICO BASE DU PULVÉRIZATEUR ÉLECTRIQUE		1	PJB-C, PJB, DJB	8424.90.90	7896660890302
33	1223781	CARREGADOR COM PLUG TIPO C PLUG TYPE C CHARGER CARGADOR CON PLUG TIPO C CHARGEUR TYPE C		1	PJB, DJB	8504.40.10	7896660894133
34	1220951	ALAVANCA DO REGISTRO LP 601 TRIGGER VALVE LEVER LP 601 PALANCA DEL REGISTRO LP 601 LEVIER DU ROBINET LP 601		20	PJH, PJ, XP, HD, PJB-C, PJB, DJB	8424.90.90	7909436923989

Nº	CÓDIGO CODE	DESCRIÇÃO DESCRIPTION DESCRIPCIÓN	IMAGEM IMAGE IMAGEN	QT. QTY. CT.	UTILIZAÇÃO UTILIZATION UTILIZACIÓN UTILISER	NCM HS CODE	EAN BARCODE
35	996058	TAMPA DO REGISTRO LP 601/605 COM VEDAÇÃO TRIGGER VALVE CAP LP 601/ 605 AND SEAL TAPA DEL REGISTRO LP 601/605 CON VEDACIÓN COUVERCLE DU ROBINET LP 601/605 AVEC JOINT		20	PJH, PJ, XP, HD, PJB-C, PJB, DJB	8481.90.90	7909436923972
36	1220962	CABO DO REGISTRO LP 601 TRIGGER VALVE HANDLE LP 601 CABO DEL REGISTRO LP 601 POIGNÉE DU ROBINET LP 601		5	PJH, PJ, XP, HD, PJB-C, PJB, DJB	8424.90.90	7909436924115
37	1230971	AGULHA LATÃO DO REGISTRO TRIGGER VALVE NEEDLE AGUJA DEL REGISTRO AIGUILLE DU ROBINET		20	PJH, PJ, XP, HD, PJB-C, PJB, DJB	8424.90.90	7896660860046
38	1220966	PINÇA LP 601 CLIP LP 601 PINZA LP 601 FERMETURE LP 601		20	PJH, PJ, XP, HD, PJB-C, PJB, DJB	3926.90.90	7909436924474
39	1220968	CORPO DO REGISTRO LP 601 TRIGGER VALVE BODY LP 601 CUERPO DEL REGISTRO LP 601 CORPS DU REGISTRE LP 601		5	PJH, PJ, XP, HD, PJB-C, PJB, DJB	8481.90.90	7909436924603
40	1220969	PORCA CÔNICA 11/16 SCREW CAP 11/16 TUERCA CONICA 11/16 BOULON CONIQUE 11/16		10	PJH, PJ, XP, HD, PJB-C, PJB, DJB	3926.90.90	7909436924924
41	635276	JUNÇÃO E JUNTA CÔNICA JOINT AND CONE PACKING UNIÓN CON JUNTA CÓNICA JOINT AND CONE PACKING		10	PJH, PJ, XP, HD, PJB-C, PJB, DJB	3917.40.90	7909436931311
42	100131	TUBO DE PULVERIZAÇÃO STAINLESS STEEL LANCE TUBO DE PULVERIZACIÓN TUBE DE PULVÉRISATION		1	PJH, PJ, XP, HD, PJB-C, PJB, DJB	8424.90.90	7896821501252
43	1168545	FILTRO DO BICO M50/60 NOZZLE FILTER M50/60 FILTRO DE LA BOQUILLA M50/60 FILTRE DE LA BUSE M50/60		20	PJH, PJ, XP, HD, PJB-C, PJB, DJB	8424.90.90	7896660860053
44	1168547	BICO JD 12 JD 12 NOZZLE BOQUILLA JD 12 BUSE JD 12		50	PJH, PJ, XP, HD, PJB-C, PJB, DJB	8424.90.90	7909436924856
45	1220972	JUNTA CÔNICA CONE PACKING JUNTA CONICA JOINT CONIQUE		20	PJH, PJ, XP, HD, PJB-C, PJB, DJB	3926.90.90	7909436925037
46	1168546	CAPA DO BICO NOZZLE CAP CAPA DE LA BOQUILLA COUVERCLE DE LA BUSE		30	PJH, PJ, XP, HD, PJB-C, PJB, DJB	8424.90.90	7909436925310
47	1223850	CHAVE DE MANUTENÇÃO PJB PJB MAINTENANCE KEY LLAVE DE MANTENIMINETO PJB CLÉ ENTRETIEN PJB		1	PJB, DJB	8204.11.00	7896660894676

# PEÇAS OPCIONAIS JACTO DJB/

OPTIONAL PARTS JACTO DJB/ PIEZAS OPCIONALES JACTO DJB/ PIECES EN OPTION JACTO DJB







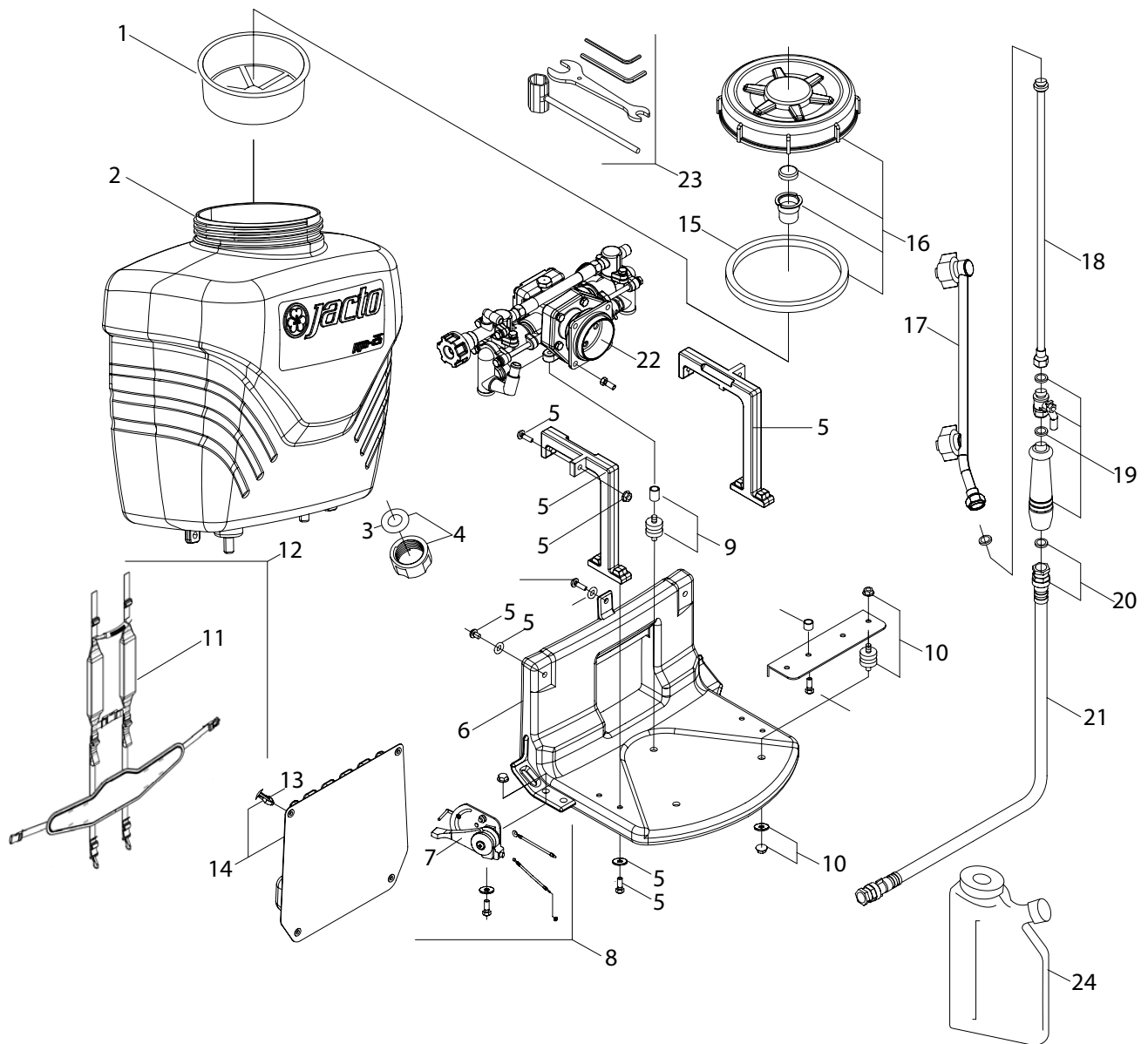



Nº	CÓDIGO CODE	DESCRIÇÃO DESCRIPTION DESCRIPCIÓN	IMAGEM IMAGE IMAGEN	QT. QTY. CT.	UTILIZAÇÃO UTILIZATION UTILIZACIÓN UTILISER	NCM HS CODE	EAN BARCODE
1	1223797	CARREGADOR COM PLUG TIPO A PLUG TYPE A CHARGER CARGADOR CON PLUG TIPO A CHARGEUR TYPE A		1	PJB, DJB	8504.40.10	7896660894140
2	1223798	CARREGADOR COM PLUG TIPO B PLUG TYPE B CHARGER CARGADOR CON PLUG TIPO B CHARGEUR TYPE B		1	PJB, DJB	8504.40.10	7896660894171
3	1223793	CARREGADOR COM PLUG TIPO F PLUG TYPE F CHARGER CARGADOR CON PLUG TIPO F CHARGEUR TYPE F		1	PJB, DJB	8504.40.10	7896660894157
4	1220642	CARREGADOR COM PLUG TIPO N PLUG TYPE N CHARGER CARGADOR CON PLUG TIPO N CHARGEUR TYPE N		1	PJB, DJB	8504.40.10	7896660890319
5	1245614	CARREGADOR COM PLUG TIPO G PLUG TYPE G CHARGER CARGADOR CON PLUG TIPO G CHARGEUR TYPE G		1	PJB, DJB	8504.40.10	7909436901826
6	1255166	CARREGADOR COM PLUG TIPO I PLUG TYPE I CHARGER CARGADOR CON PLUG TIPO I CHARGEUR TYPE I		1	PJB, DJB	8504.40.10	7909436920827
7	963959	COPO CALIBRADOR MEASURING CUP VASO CALIBRADOR DOSEUR		1	PJH, PJ, XP, HD, PJB-C, PJB, DJB	8424.90.90	7896821586136
8	1236097	DISCO Nº 40 NOZZLE JD-40 BUSE JD-40		1	PJH, PJ, XP, HD, PJB-C, PJB, DJB	8424.90.90	7909436910088



# JACTO PJM



# JACTO PJM

Nº	CÓDIGO CODE	DESCRIÇÃO DESCRIPTION DESCRIPCIÓN	IMAGEM IMAGE IMAGEN	QT. QTY. CT.	UTILIZAÇÃO UTILIZATION UTILIZACIÓN UTILISER	NCM HS CODE	EAN BARCODE
1	1242187	COADOR STRAINER CEDAZO TAMIS		1	PJM	8424.90.90	7896660801520
2	1242184	DEPOSITO PJM 20L PJM 20L TANK RÉSERVOIR PJM 20L		1	PJM	8424.90.90	7896660801018
3	1242179	VEDAÇÃO DA TAMPA DO DRENO DRAIN CAP SEAL ZAPATILLA TAPA DEL DRENO JOINT DE COUVERTURE DE VIDANGE		1	PJM	8424.90.90	7896660899183
4	1242183	TAMPA DO DRENO COM VEDAÇÃO COMPLETE DRAIN CAP TAPA COMPLETA DEL DRENO COUVERCLE DE VIDANGE AVEC JOINT		1	PJM	8424.90.90	7896660800820
5	1242250	SUPORTE COMPLETO DO CHASSI COMPLETE CHASSIS SUPPORT SOPORTE COMPLETO DEL CHASIS SUPPORT DU CHASSIS COMPLET		1	PJM	8424.90.90	7896660803173
6	1242191	CHASSI CHASSIS CHASIS		1	PJM	8424.90.90	7909436902441
7	1242189	ALAVANCA DO ACELERADOR THROTTLE LEVER PALANCA DEL ACELERADOR LEVIER D'ACCELERATEUR		1	PJM	8424.90.90	7896660802381
8	1242190	ACELERADOR COMPLETO COMPLETE THROTTLE ACCELERATEUR COMPLET		1	PJM	8424.90.90	7896660802398
9	1242197	COXIM DA BOMBA PUMP CUSHION AMORTIGUADOR DE LA BOMBA COUSSIN DE POMPE		1	PJM	8424.90.90	7909436912556
10	1242196	COXIM DO MOTOR ENGINE CUSHION AMORTIGUADOR DEL MOTOR COUSSIN DU MOTEUR		2	PJM	8424.90.90	7909436912495
11	1242165	CINTA SUPERIOR COMPLETE UPPER HARNESS CORREA SUPERIOR COMPLETA BRETELLE SUPÉRIEUR		1	PJM	8424.90.90	7896660897790
12	1236528	CINTA COMPLETA COMPLETE HARNESS CORREA COMPLETA BRETELLE COMPLET		1	PJM	8424.90.90	7896660846392
13	1242176	TRAVA DE PLASTICO PLASTIC LOCK TRABA DE PLÁSTICO SERRURE EN PLASTIQUE		4	PJM	8424.90.90	7896660898346
14	1242175	ESPUMA DO CHASSI COMPLETE CHASSIS FOAM ESPUMA DEL CHASIS COMPLETO MOUSSE DU CHASSIS		1	PJM	8424.90.90	7896660898339
15	1242180	VEDAÇÃO DA TAMPA TANK CAP SEAL ZAPATILLA TAPA DEL TANQUE SCELLEMENT DE COUVERTURE		1	PJM	8424.90.90	7896660800387
16	1242181	TAMPA DO TANQUE COM VEDAÇÃO COMPLETE TANK CAP TAPA DEL TANQUE COMPLETA RESERVOIR AVEC SCELLEMENT		1	PJM	8424.90.90	7896660800394
17	1242206	LANÇA LANCE LANZA		1	PJM	8424.90.90	7896660802466

Nº	CÓDIGO CODE	DESCRIÇÃO DESCRIPTION DESCRIPCIÓN	IMAGEM IMAGE IMAGEN	QT. QTY. CT.	UTILIZAÇÃO UTILIZATION UTILIZACIÓN UTILISER	NCM HS CODE	EAN BARCODE
18	1242207	TUBO DA LANÇA LANCE ROD TUBO DE LA LANZA TUYAU DE LA LANCE		1	PJM	8424.90.90	7896660802473
19	1242235	REGISTRO COMPLETO COMPLETE VALVE VÁLVULA COMPLETA ROBINET COMPLET		1	PJM	8424.90.90	7896660802596
20	1242241	CONEXÃO GIRATORIA DA MANGUEIRA HOSE ROTATING CONNECTION CONEXIÓN GIRATORIA DE LA MANGUERA RACCORDEMENT TOURNANT DU TUYAU		1	PJM	8424.90.90	7896660803159
21	1242209	MANGUEIRA HOSE MANGUERA TUYAU		1	PJM	8424.90.90	7896660802480
22	1242195	BOMBA DE PISTÃO COMPLETA COMPLETE PISTON PUMP BOMBA PISTÓN COMPLETA POMPE À PISTON COMPLET		1	PJM	8424.90.90	7896660802435
23	1242231	KIT DE FERRAMENTAS TOOL KIT KIT DE HERRAMIENTAS KIT D'OUTILS		1	PJM	8424.90.90	7896660802589
24	1242188	MEDIDOR DE COMBUSTÍVEL FUEL MEASURING BOTTLE MEDIDOR DE COMBUSTIBLE MESUREUR DE CARBURANT		1	PJM	8424.90.90	7896660801704

BOMBA/PUMP/POMPE

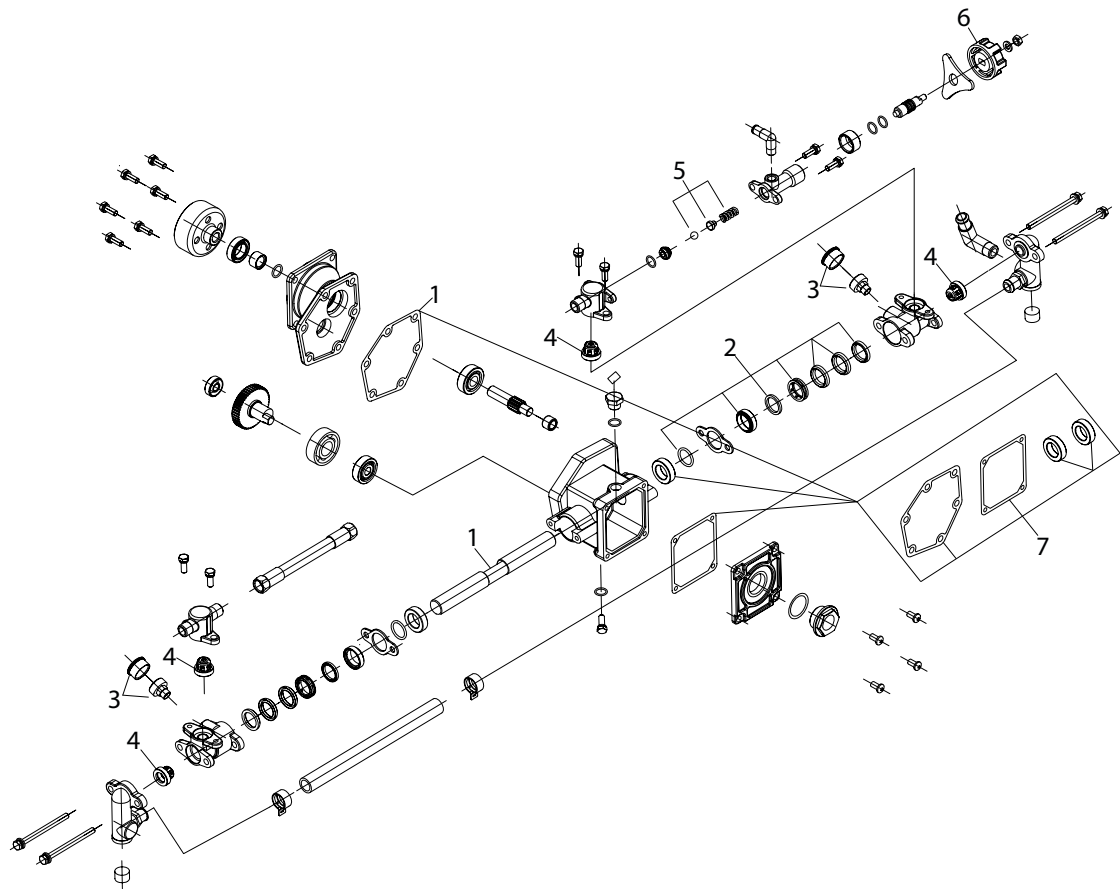





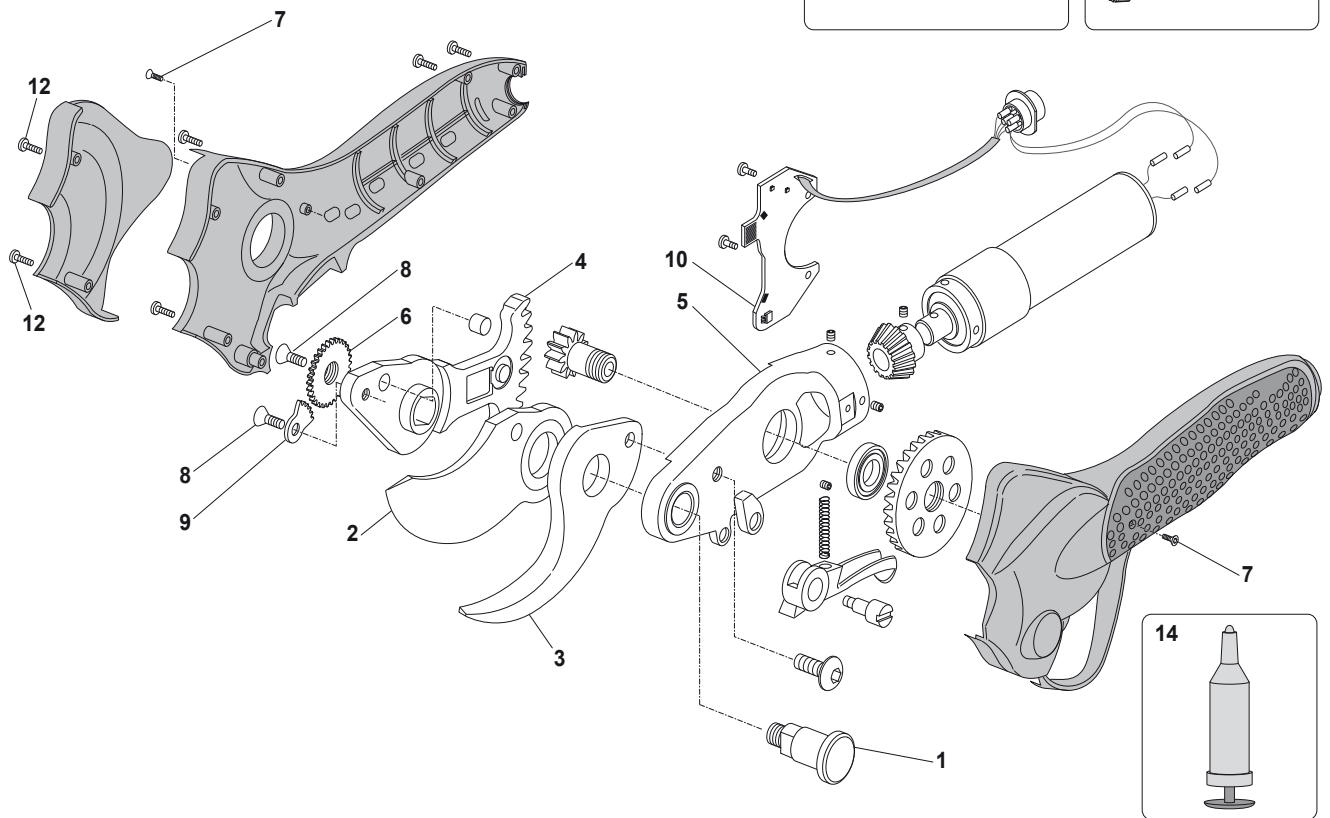









Nº	CÓDIGO CODE	DESCRIÇÃO DESCRIPTION DESCRIPCIÓN	IMAGEM IMAGE IMAGEN	QT. QTY. CT.	UTILIZAÇÃO UTILIZATION UTILIZACIÓN UTILISER	NCM HS CODE	EAN BARCODE
1	1242252	<b>CONJUNTO PISTÃO DA BOMBA C/ VEDAÇÃO</b> PUMP PISTON ASSEMBLY WITH SEAL CONJUNTO PISTÓN DE LA BOMBA CON CIERRE HERMÉTICO ENSEMBLE PISTON DE POMPE AVEC SCELLEMENT		1	PJM	8413.91.90	7896660803197
2	1242263	<b>CONJUNTO DE ANÉIS DE VEDAÇÃO</b> SEAL RING ASSEMBLY CONJUNTO DE ANILLO DE CIERRE HERMÉTICO JEU DES ANNEAUX DE SCELLEMENT		1	PJM	8424.90.90	7896660803272
3	1242264	<b>GRAXEIRA COMPLETA</b> COMPLETE GRESE CUP ENGRASADORA COMPLETA GRAISSEUR COMPLETE		1	PJM	8424.90.90	7896660803289
4	1242212	<b>CONJUNTO DE VÁLVULAS</b> VALVE ASSEMBLY CONJUNTO VÁLVULA SET DE VALVE		4	PJM	8424.90.90	7909436906760
5	1242205	<b>CONJUNTO MOLA DO RETORNO</b> RETURN SPRING ASSEMBLY CONJUNTO RESORTE DEL RETORNO KIT DU RESORT DU RETOUR		1	PJM	8424.90.90	7896660802459
6	1242245	<b>MANOPLA DO RETORNO</b> RETURN GRIP MANIJA CON ROSCA DEL RETORNO POIGNEE DE RETOUR		1	PJM	8424.90.90	7896660803166
7	1242251	<b>CONJUNTO DO RETENTOR DA BOMBA</b> PUMP O-RING ASSEMBLY CONJUNTO DE JUNTA HERMÉTICA DE LA BOMBA ENSEMBLE DE RETENT DE LA POMPE		1	PJM	8413.91.90	7896660803180

# JACTO PR-40









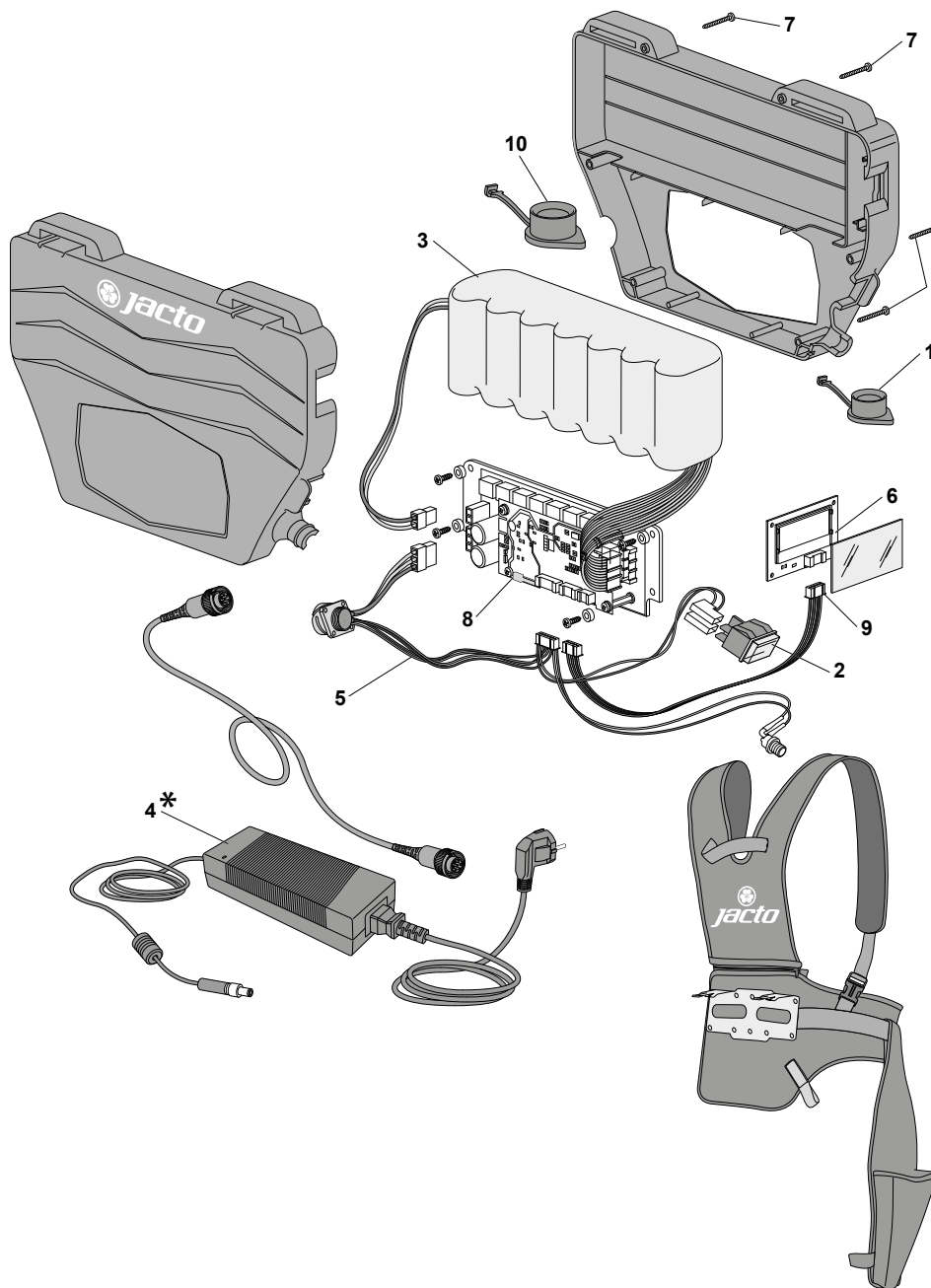

JACTO PR-40

Nº	CÓDIGO CODE	DESCRIÇÃO DESCRIPTION DESCRIPCIÓN	IMAGEM IMAGE IMAGEN	QT. QTY. CT.	UTILIZAÇÃO UTILIZATION UTILIZACIÓN UTILISER	NCM HS CODE	EAN BARCODE
1	1236423	PARAFUSO DA LÂMINA SHEAR BLADE BOLT TORNILLO DE LA HOJA VIS À LAME		1	PR-40	7318.15.00	7896660846279
2	1236425	LÂMINA L1 BLADE L1 CUCHILLA L1 LAME L1		1	PR-40	8467.99.00	7896660846286
3	1236426	CONTRA LÂMINA CL1 COUNTER BLADE CL1 CONTRA CUCHILLA CL1 CONTRE LA LAME CL1		1	PR-40	8467.99.00	7896660846293
4	1236428	CREMALHEIRA DA ENGENRAGEM GEAR RACK CREMALLERA DE LA ENGRANAJE CRÉMAILLÈRE DE ENGRENAGE		1	PR-40	8467.99.00	7896660846422
5	1236429	QUADRO MECÂNICO DE ALUMÍNIO ALUMINIUM MECHANIC FRAME CUADRO MECÁNICO DE ALUMÍNIO CADRE MECANIQUE EN ALUMINIUM		1	PR-40	8467.99.00	7896660846439
6	1236430	PORCA DA LÂMINA BLADE NUT TUERCA DE LA HOJA ECROU DE LAME		1	PR-40	7318.16.00	7896660846446
7	1236431	PARAFUSO TSPEI M3X8 SCREW TSPEI M3X8 TORNILLO TSPEI M3X8 VIS TSPEI M3X8		1	PR-40	7318.15.00	7896660846453
8	1236433	PARAFUSO TC-IC M4X6 SCREW TC-IC M4X6 TORNILLO TC-IC M4X6 VIS TC-IC M4X6		1	PR-40	7318.15.00	7896660846460
9	1236435	TRAVA DA PORCA NUT LOCK TRABA DE LA TUERCA VERROU DU ECROU		1	PR-40	8467.99.00	7896660846477
10	1236438	PAINEL ELÉTRICO C/CABO E CONECTOR INTERNAL ELETR BOARD W/CABLE & PLUG PANTALLA ELECTRÓNICA CON CABLE Y CONECTOR PANNEAU ELECTRIQUE AVEC CABLE ET CONNECTEUR		1	PR-40	8467.99.00	7896660846484
11	1236440	CABO DE CONEXÃO CONNECTING CABLE CABLE DE CONEXIÓN CABLE DE CONNEXION		1	PR-40	8544.42.00	7896660846491
12	1236442	PARAFUSO TCBIC D.3X20 SCREW TCBIC D.3X20 TORNILLO TCBIC D.3X20 VIS TCBIC D.3X20		1	PR-40	7318.15.00	7896660846514
13	1236445	KIT MOTOR E REDUTOR MOTOR AND GEAR REDUCTOR KIT KIT DE MOTOR Y REDUCTOR REDUCTEUR		1	PR-40	8501.31.10	7896660846521
14	1236446	SERINGA DE GRAXA GREASE SYRINGE JERINGA DE GRASA SERINGUE À GRAISSE		1	PR-40	8467.99.00	7896660846538

BATERIA/BATTERY

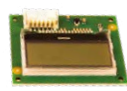

# JACTO PR-40

Nº	CÓDIGO CODE	DESCRIÇÃO DESCRIPTION DESCRIPCIÓN	IMAGEM IMAGE IMAGEN	QT. QTY. CT.	UTILIZAÇÃO UTILIZATION UTILIZACIÓN UTILISER	NCM HS CODE	EAN BARCODE
1	1236448	CAPA PROTETORA DO CABO DO CARREGADOR CHARGER CABLE PROTECTIVE COVER CAPA DE LA GOMA DEL CABLE DEL CARGADOR COUVERCLE DE CAOUTCHOUC DE BATTERIE - CHARGEUR		1	PR-40	8467.99.00	7896660846545
2	1236449	INTERRUPTOR SWITCH COMMUTATEUR		1	PR-40	8467.99.00	7896660846552
3	1236450	BATERIA LI-ION LI-ION 5,8AH PACK BATERÍA LIT ION BATTERIE LI-ION		1	PR-40	8507.60.00	7896660846590
4	1241234	CARREGADOR COM PLUG TIPO N/ PLUG TYPE N CHARGER/ CARGADOR CON PLUG TIPO N/ CHARGEUR TYPE N		1	PR-40	8424.90.90	7896660886930
5	1236454	CABO INTERNO COM CONECTOR INTERNAL CABLE W/ CONNECTOR CABLE INTERNO CON CONECTOR CABLE INTERNE AVEC CONNECTEUR		1	PR-40	8467.99.00	7896660846675
6	1236455	TELA DIGITAL DIGITAL DISPLAY PANTALLA DIGITAL ECRAN NUMERIQUE		1	PR-40	8467.99.00	7896660846682
7	1236456	PARAFUSO TCIC D4X25 SCREW TCIC D4X25 TORNILLO TCIC D4X25 VIS TCIC D4X25		1	PR-40	7318.15.00	7896660846699
8	1236457	PLACA ELÉTRICO C/ BMS E INVERSOR ELECTRONIC BOARD W/ BMS & INVERTER TABLERO ELÉCTRICO C/ BMS E INVERSOR PLAQUE ELETRIQUE AVEC MBMS ET INVERSEUR		1	PR-40	8467.99.00	7896660846736
9	1236458	KIT DO CABO DO DISPLAY DISPLAY CABLE KIT KIT DEL CABLE DE LA PANTALLA KIT DE CÂBLE D'AFFICHAGE		1	PR-40	8467.99.00	7896660846743
10	1236459	CAPA PROTETORA DO CABO DA TESOURA PRUNER CABLE PROTECTIVE COVER CAPA DE LA GOMA DEL CABLE DE LA TIJERA COUVERCLE DE CAOUTCHOUC BAT-TES		1	PR-40	8467.99.00	7896660846750

## PEÇAS OPCIONAIS JACTO PR-40/

OPTIONAL PARTS JACTO PR-40/ PIEZAS OPCIONALES JACTO PR-40/ PIECES EN OPTION JACTO PR-40









Nº	CÓDIGO CODE	DESCRIÇÃO DESCRIPTION DESCRIPCIÓN	IMAGEM IMAGE IMAGEN	QT. QTY. CT.	UTILIZAÇÃO UTILIZATION UTILIZACIÓN UTILISER	NCM HS CODE	EAN BARCODE
1	1241241	CARREGADOR COM PLUG TIPO B PLUG TYPE B CHARGER CARGADOR CON PLUG TIPO B CHARGEUR TYPE B		1	PR-40	8424.90.90	7896660887258
2	1241240	CARREGADOR COM PLUG TIPO I PLUG TYPE I CHARGER CARGADOR CON PLUG TIPO I CHARGEUR TYPE I		1	PR-40	8424.90.90	7896660887241
3	1241235	CARREGADOR COM PLUG TIPO L PLUG TYPE L CHARGER CARGADOR CON PLUG TIPO L CHARGEUR TYPE L		1	PR-40	8424.90.90	7896660887234
4	1235486	EXTENSÃO PR-40 EXTENSION PR-40 EXTENSIÓN PR-40		1	PR-40	8467.99.00	7896660840079



# ACESSÓRIOS/ ACCESSORIES/ ACCESORIOS/ ACCESSOIRES

CÓDIGO CODE	DESCRIÇÃO DESCRIPTION DESCRIPCIÓN	IMAGEM IMAGE IMAGEN	QT. QTY. CT.	UTILIZAÇÃO UTILIZATION UTILIZACIÓN UTILISER	NCM HS CODE	EAN BARCODE
1222737	PROTECTOR TIPO CHAPÉU SPRAY GUARD PROTECTOR TIPO CAMPANA CLOCHE DE PROTECTION		1	PJ, PJH, XP, HD, PJBC, PJB, DJB	8424.90.90	7896660895147
761882	PROTECTOR TIPO CHAPÉU II SPRAY GUARD II PROTECTOR TIPO CAMPANA II CLOCHE DE PROTECTION II		1	PJ, PJH, XP, HD, PJBC, PJB, DJB	8424.90.90	7896821573570
560300	LANCA COMPLETA 1700 COM REGISTRO LP6 01 COMPLETE LANCE 1700 AND TRIGGER VALVE LP 601 LANZA COMPLETA 1700 Y REGISTRO LP 601 LANCE COMPLÈTE 1700 ET ROBINET LP 601		1	PJ, PJH, XP, HD, PJBC, PJB, DJB	8424.90.90	7896821581957
560342	TUBO DE PULVERIZAÇÃO 1700 STAINLESS STEEL LANCE 1700 TUBO DE PULVERIZACIÓN 1700 TUBE DE PULVÉRISATION 1700		1	PJ, PJH, XP, HD, PJBC, PJB, DJB	8424.90.90	7896821508138
1222736	BARRA CANTEIRO BED BOOM BARRA CANTERO BARRE MARÁICHAGE		1	PJ, PJH, XP, HD, PJBC, PJB, DJB	8424.90.90	7896660895130
1222718	BARRA 500 BOOM 500 BARRE 500		1	PJ, PJH, XP, HD, PJBC, PJB, DJB	8424.90.90	7896660895093
907873	BARRA MOLDÁVEL ADJUSTABLE BOOM BARRA AJUSTABLE BARRE PLIABLE		1	PJ, PJH, XP, HD, PJBC, PJB, DJB	8424.90.90	7896821548783
1222729	EXTENSÃO 600 EXTENSION 600 EXTENSIÓN 600		1	PJ, PJH, XP, HD, PJBC, PJB, DJB	8424.90.90	7896660895109
1222733	EXTENSÃO 160 EXTENSION 160 EXTENSIÓN 160		1	PJBC, PJB, DJB	8424.90.90	7896660895123
1222730	BICO Y NOZZLE Y BOQUILLA Y BUSE Y		1	PJ, PJH, XP, HD, PJBC, PJB, DJB	8424.90.90	7896660895116
834309	CALIBRADOR CALIBRATION BOTTLE VASO CALIBRADOR CALIBRATEUR		1	PJ, PJH, XP, HD	9026.10.19	7896821579121
1197164	ECOVALVE VERDE (15 PSI) GREEN ECOVALVE (15 PSI) ECOVALVE VERT (15 PSI)		1	PJ, PJH, XP, HD	8481.10.00	7896660861012
1197159	ECOVALVE AMARELO (22,5 PSI) YELLOW ECOVALVE (22,5 PSI) ECOVALVE JAUNE (22,5)		1	PJ, PJH, XP, HD	8481.10.00	7896660861050
1197163	ECOVALVE AZUL (30 PSI) BLUE ECOVALVE (30 PSI) ECOVALVE BLEU (30 PSI)		1	PJ, PJH, XP, HD	8481.10.00	7896660861067
1197162	ECOVALVE VERMELHO (45 PSI) RED ECOVALVE (45 PSI) ECOVALVE ROJO (45 PSI) ECOVALVE ROUGE (45 PSI)		1	PJ, PJH, XP, HD	8481.10.00	7896660861074
323725	BICO CONE REGULÁVEL AMARELO YELLOW ADJUSTABLE CONE NOZZLE BOQUILLA CONO AJUSTABLE AMARILLO BUSE CÔNE RÉGLABLE JAUNE		10	PJ, PJH, XP, HD, PJBC, PJB, DJB	8424.90.90	17896821547653
15024	BICO CONE REGULÁVEL VERMELHO RED ADJUSTABLE CONE NOZZLE BOQUILLA CONO AJUSTABLE ROJO BUSE CÔNE RÉGLABLE ROUGE		10	PJ, PJH, XP, HD, PJBC, PJB, DJB	8424.90.90	17896821558949
1222664	BICO CONE REGULÁVEL AZUL BLUE ADJUSTABLE CONE NOZZLE BOQUILLA CONO AJUSTABLE AZUL BUSE CÔNE RÉGLABLE BLEU		10	PJ, PJH, XP, HD, PJBC, PJB, DJB	8424.90.90	7909436928588

ACESSÓRIOS/ ACCESSORIES/ ACCESORIOS/ ACCESSOIRES

CÓDIGO CODE	DESCRIÇÃO DESCRIPTION DESCRIPCIÓN	IMAGEM IMAGE IMAGEN	QT. QTY. CT.	UTILIZAÇÃO UTILIZATION UTILIZACIÓN UTILISER	NCM HS CODE	EAN BARCODE
1196633	KIT DOSADOR DOSER KIT KIT DOSIFICADOR KIT DE DOSAGE		1	PJ, PJH	8424.90.90	7896660852003
1240374	CÂMARA DOSADORA DOSER CHAMBER CÂMARA DEL DOSIFICADOR CHAMBRE DE DOSAGE		1	PJ, PJH	8424.90.90	7896660873978
1195283	INJETOR DE SOLO SOIL INJECTOR INYECTOR DEL LIQUIDO INJECTEUR DE SOL		1	PJ, PJH, XP, HD	8424.90.90	7896660844305
1236093	LANÇA ANTIBROTANTE ANTI-GROWTH LANCE LANZA ANTIBROTANTE LANCE ANTI-GERMINATION		1	PJ, PJH, XP, HD, PJBC, PJB, DJB	8424.90.90	7896660872582
1236498	CINTA DELUXE PJH PJH DELUXE HARNESS COURROIE DE LUXE PJH		1	PJ, PJH, PLUS	8424.90.90	7896660847047
1236495	CINTA DELUXE XP XP DELUXE HARNESS COURROIE DE LUXE XP		1	XP	8424.90.90	7896660846910
1236493	CINTA DELUXE HD-400 HD-400 DELUXE HARNESS COURROIE DE LUXE HD-400		1	HD-400	8424.90.90	7896660846941
1236494	CINTA DELUXE HD-550 HD-550 DELUXE HARNESS COURROIE DE LUXE HD-550		1	HD-550	8424.90.90	7896660846972
1236496	CINTA DELUXE PJB/DJB PJB/DJB DELUXE HARNESS COURROIE DE LUXE PJB/DJB		1	PJB, DJB	8424.90.90	7896660846903

# CONEXÃO DOS ACESSÓRIOS/

ACCESSORY CONNECTIONS/ CONEXIONES DE ACCESORIOS/ CONNEXIONS ACCESSOIRES

CÓDIGO CODE	DESCRIÇÃO DESCRIPTION DESCRIPCIÓN	IMAGEM IMAGE IMAGEN	QT. QTY. CT.	NCM HS CODE	EAN BARCODE
1222708	CONEXÃO BICO L NOZZLE L CONNECTION CONEXIÓN BOQUILLA L CONNEXION BUSE L		1	8424.90.90	7896660895727
1222709	CONEXÃO L CONNECTION L CONEXIÓN L CONNEXION L		1	8424.90.90	7896660895734
1222712	CONEXÃO T CONNECTION T CONEXIÓN T CONNEXION T		1	8424.90.90	7896660895543
1254657	CONEXÃO BICO T NOZZLE T CONNECTION CONEXIÓN BOQUILLA T CONNEXION BUSE T		1	3917.39.00	7909436920124
1222710	CONEXÃO CONNECTION CONEXIÓN CONNEXION		1	8424.90.90	7896660895741
1222713	TUBO 61 TUBE 61		1	8424.90.90	7896660895550
1222715	TUBO 102 TUBE 102		1	8424.90.90	7896660895765
1222714	TUBO 227 TUBE 227		1	8424.90.90	7896660895567
1222717	PORCA E CONTRA PORCA NUT AND LOCK NUT TUERCA Y CONTRA TUERCA ÉCROU ET CONTRE-ÉCROU		1	8424.90.90	7896660895772

# REGISTROS/ TRIGGER VALVE/ ROBINET

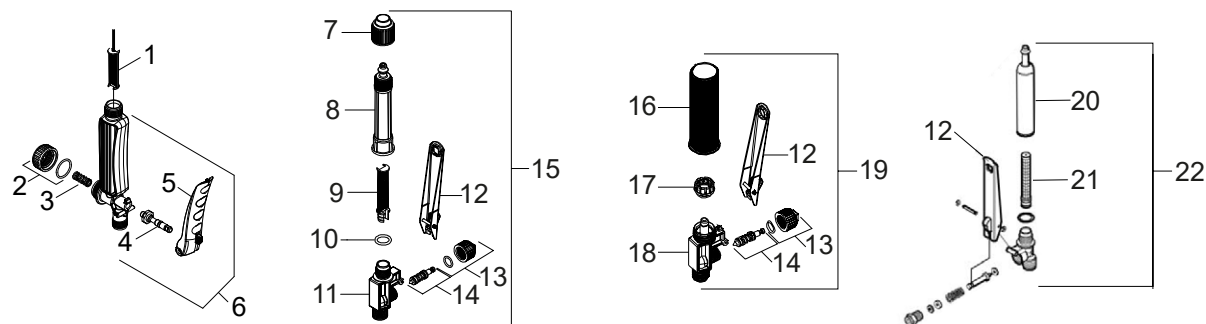

Nº	CÓDIGO CODE	DESCRIÇÃO DESCRIPTION DESCRIPCIÓN	IMAGEM IMAGE IMAGEM	QT. QTY. CT.	UTILIZAÇÃO UTILIZATION UTILIZACIÓN UTILISER	NCM HS CODE	EAN BARCODE
1	1168418	FILTRO LP-3 FILTER LP-3 FILTRE LP-3		20	PJH, PJ, XP, HD, PJB-C, PJB, DJB	8424.90.90	7909436913560
2	1168544	TAMPA DO REGISTRO C/ VEDAÇÃO TRIGGER VALVE CAP AND RING TAPA DEL REGISTRO CON VEDACION COUVERCLE DU ROBINET		10	PJH, PJ, XP, HD, PJB-C, PJB, DJB	3926.90.90	7909436921138
3	1222660	MOLA SPRING RESORTE RESSORT		10	PJH, PJ, XP, HD, PJB-C, PJB, DJB	7320.90.00	7909436921022
4	1168422	AGULHA LP-3 C/ VEDAÇÕES NEEDLE LP-3 AND RINGS AGUJA LP-3 CON VEDACION AIGUILLE COMPLÈTE LP-3		1	PJH, PJ, XP, HD, PJB-C, PJB, DJB	8481.90.90	7899144899037
5	1168421	ALAVANCA DO REGISTRO LP-3 TRIGGER VALVE LEVER LP-3 PALANCA DEL REGISTRO LP-3 LEVIER COMPLET LP-3		10	PJH, PJ, XP, HD, PJB-C, PJB, DJB	8424.90.90	7909436921053
6	1168419	REGISTRO COMPLETO LP-3 TRIGGER VALVE ASSEMBLY LP-3 ROBINET COMPLÈTE LP-3		1	PJH, PJ, XP, HD, PJB-C, PJB, DJB	8481.80.99	7899144898900
7	942193	PORCA S20 X 1,5 SCREW CAP S20 X 1,5 TUERCA S20 X 1,5 ÉCROU S20 X 1,5		1	PJH, PJ, XP, HD, PJB-C, PJB, DJB	3926.90.90	7896821551912
8	942177	CABO DO REGISTRO LP 605 TRIGGER VALVE HANDLE LP 605 CABO DEL REGISTRO LP 605 POIGNÉE DU ROBINET LP 605		5	PJH, PJ, XP, HD, PJB-C, PJB, DJB	8424.90.90	17896821548810
9	1152734	FILTRO LP 605 FILTER LP 605 FILTRE LP 605		10	PJH, PJ, XP, HD, PJB-C, PJB, DJB	8424.90.90	27899144894203
10	244459	O-RING OR1-113		5	PJH, PJ, XP, HD, PJB-C, PJB, DJB	8424.90.90	17896821524531
11	942367	CORPO DO REGISTRO LP 605 TRIGGER VALVE BODY LP 605 CUERPO DEL REGISTRO LP 605 CORPS DU REGISTRE LP 605		5	PJH, PJ, XP, HD, PJB-C, PJB, DJB	8481.90.90	7896660885773
12	1220951	ALAVANCA DO REGISTRO LP 601 TRIGGER VALVE LEVER LP 601 PALANCA DEL REGISTRO LP 601 LEVIER DU ROBINET LP 601		20	PJH, PJ, XP, HD, PJB-C, PJB, DJB	8424.90.90	7909436923989

Nº	CÓDIGO CODE	DESCRIÇÃO DESCRIPTION DESCRIPCIÓN	IMAGEM IMAGE IMAGEM	QT. QTY. CT.	UTILIZAÇÃO UTILIZATION UTILIZACIÓN UTILISER	NCM HS CODE	EAN BARCODE
13	996058	TAMPA DO REGISTRO LP 601/605 COM VEDAÇÃO TRIGGER VALVE CAP LP 601/ 605 AND SEAL TAPA DEL REGISTRO LP 601/605 CON VEDACIÓN COUVERCLE DU ROBINET LP 601/605 AVEC JOINT		20	PJH, PJ, XP, HD, PJB-C, PJB, DJB	8481.90.90	7909436923972
14	1230971	AGULHA DO REGISTRO TRIGGER VALVE NEEDLE AGUJA DEL REGISTRO AIGUILLE DU ROBINET		20	PJH, PJ, XP, HD, PJB-C, PJB, DJB	8424.90.90	7896660860046
15	1222831	REGISTRO COMPLETO LP 605 TRIGGER VALVE LP 605 REGISTRO COMPLETO LP 605 ROBINET COMPLÈTE LP 605		1	PJH, PJ, XP, HD, PJB-C, PJB, DJB	8424.90.90	7896660896564
16	1220962	CABO DO REGISTRO LP 601 TRIGGER VALVE HANDLE LP 601 CABO DEL REGISTRO LP 601 POIGNÉE DU ROBINET LP 601		5	PJH, PJ, XP, HD, PJB-C, PJB, DJB	8424.90.90	7909436924115
17	1220966	PINÇA LP 601 CLIP LP 601 PINZA LP 601 FERMETURE LP 601		20	PJH, PJ, XP, HD, PJB-C, PJB, DJB	3926.90.90	7909436924474
18	1220968	CORPO DO REGISTRO LP 601 TRIGGER VALVE BODY LP 601 CUERPO DEL REGISTRO LP 601 CORPS DU REGISTRE LP 601		5	PJH, PJ, XP, HD, PJB-C, PJB, DJB	8481.90.90	7909436924603
19	1217605	REGISTRO COMPLETO LP 601 TRIGGER VALVE LP 601 REGISTRO COMPLETO LP 601 ROBINET COMPLÈTE LP 601		20	PJH, PJ, XP, HD, PJB-C, PJB, DJB	8481.80.99	7896660870397
20	826958	CABO DO REGISTRO METÁLICO METALLIC TRIGGER VALVE HANDLE CABO DEL REGISTRO METALIZADO POIGNÉE DU ROBINET MÉTALLIQUE		1	PJH, PJ, XP, HD, PJB-C, PJB, DJB	7312.90.00	7896821547861
21	825653	FILTRO METÁLICO METALLIC FILTER FILTRO METALIZADO FILTRE MÉTALLIQUE		1	PJH, PJ, XP, HD, PJB-C, PJB, DJB	8424.90.90	7896821551905
22	727727	REGISTRO METÁLICO COMPLETO METALLIC TRIGGER VALVE REGISTRO METALIZADO COMPLETO ROBINET MÉTALLIQUE COMPLÈTE		1	PJH, PJ, XP, HD, PJB-C, PJB, DJB	8481.80.99	7896821501290



Jacto 2019  
©Todos os direitos reservados.

A Jacto se reserva o direito de promover modificações em seus produtos sem prévio aviso.

Este documento não supre a necessidade de leitura atenta ao manual de instruções por parte do operador.

ver. 02 - 14/08/2019

---

Jacto 2019  
© All rights reserved.

Jacto reserves the right to make changes in its products without prior notice

This document does not exempt users from closely reading the operator's manual.

ver. 02 - 14/08/2019

---

Jacto 2019  
©Todos los derechos reservados

Jacto se reserva el derecho de hacer modificaciones en sus productos sin previo aviso.

Este documento no supe la necesidad de lectura atenta del manual de instrucciones por parte del operador.

ver. 02 - 14/08/2019

Rua Dr. Luiz Miranda, 1650  
17580-000 Pompéia - SP Brasil

Tel. +55 (14) 3405 2100  
E-mail: [jsfs@jacto.com.br](mailto:jsfs@jacto.com.br)  
[www.jacto.com](http://www.jacto.com)

